

2023

 **Comfortex**
WINDOW FASHIONS

Distributed by:

 **MDS** Midwest
WINDOW FASHIONS Designer
Supply

1-888-523-2611



COMFOTEX CELLULAR SHADES

Manufacturer's Price List and Reference Guide

Effective April 17, 2023



Detailed Table of Contents



Hardware



Photos



Price Grids



Videos



Product Specifications



Installation



General Information



Web



 Requires you to leave document

Comfortex Cellular Shades Price List - Effective 04.17.2023

Version 1

Original Price List Effective April 17, 2023

Uploaded 03/17/2023



Hardware Options



Size Standards



Hardware Options Pricing







Scotchgard™ Protection

Optional Scotchgard™ Protector is available with all Color Lux fabrics. Scotchgard™ keeps your shades looking newer, fresher and cleaner longer.

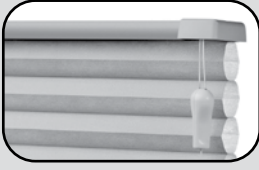

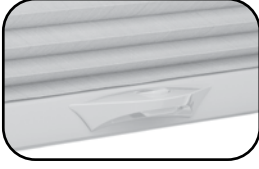

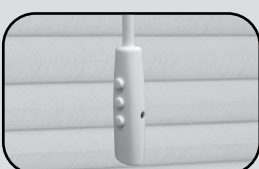
A combination of the latest advances in stain release and repellency provides exceptional stain protection. Spills wipe away easily and most dirt and stains lift out when cleaned.

Cellular Shade Collection
HARDWARE OPTIONS

| | Key Features | Color Options | Hardware Size (Depth x Height) | Widths & Lengths* | More Information |
|--|--|--|---|---|------------------|
| <p>Cord Lock</p>  | <ul style="list-style-type: none"> Reliable cord lock Sleek, color coordinated rails UV resistant materials | <ul style="list-style-type: none"> Color Coordinated Fabric Wrapped Oil Rubbed Bronze | <p>Standard Head Rail: 1 7/8" x 1/2"</p> <p>Deluxe Head Rail: 2 3/8" x 1/2"</p> | <p>Width: 8" up to 144"</p> <p>Length: 8" up to 120"</p> | <p>Page 44</p> |
| <p>Cord Loop</p>  | <ul style="list-style-type: none"> Great for large windows Smooth & quiet operation | <ul style="list-style-type: none"> Color Coordinated Fabric Wrapped Oil Rubbed Bronze | <p>2 1/4" x 1 1/2"</p> | <p>Width: 14" up to 144"</p> <p>Length: 8" up to 120"</p> | <p>Page 46</p> |
| <p>Cordless Ultra</p>  | <ul style="list-style-type: none"> Child safe No visible cords Smooth & quiet operation Sleek clear handle on rails Two-On-One option available | <ul style="list-style-type: none"> Color Coordinated Fabric Wrapped Oil Rubbed Bronze | <p>2 1/4" x 1 1/2"</p> | <p>Width: 18" up to 144"</p> <p>Length: 8" up to 84"</p> | <p>Page 48</p> |
| <p>Cordless Lift & Lock</p>  | <ul style="list-style-type: none"> Child safe Easy push button operation Rails lock securely in place in any position Color coordinated rails and handle | <ul style="list-style-type: none"> Color Coordinated Fabric Wrapped Oil Rubbed Bronze | <p>Standard Head Rail: 1 7/8" x 1/2"</p> <p>Deluxe Head Rail: 2 3/8" x 1/2"</p> <p>Bottom Rail: 1 7/8" x 1 1/8"</p> | <p>Width: 16" up to 96"</p> <p>Length: 8" up to 84"</p> | <p>Page 50</p> |
| <p>12V Non-Rechargeable Simplicity Motorization</p>  | <ul style="list-style-type: none"> Raise & lower shade with click of a button Great for large and hard to reach windows Remote can operate multiple shades | <ul style="list-style-type: none"> Color Coordinated Fabric Wrapped Oil Rubbed Bronze | <p>2 1/4" x 1 1/2"</p> | <p>Width: 18" to 108"</p> <p>Length: 8" to 120"</p> | <p>Page 52</p> |
| <p>7.4V Rechargeable Simplicity Motorization</p>  | <ul style="list-style-type: none"> Raise & lower shade with click of a button Great for large and hard to reach windows Remote can operate multiple shades Standard or Top Down-Bottom Up | <ul style="list-style-type: none"> Color Coordinated Fabric Wrapped Oil Rubbed Bronze | <p>2 1/4" x 1 1/2"</p> | <p>Width: 18" up to 108"</p> <p>Length: 8" up to 120"</p> | <p>Page 57</p> |
| <p>7.4V Rechargeable PowerTouch™ Cordless Wand</p>  | <ul style="list-style-type: none"> Raise & lower shade with push of a button Just "Touch & Go" to operate the shade Set your favorite shade position Easy access to charging port on side of pendant | <ul style="list-style-type: none"> Wand and pendant available in white or black | <p>2 1/4" x 1 1/2"</p> | <p>Width: 18" up to 144"</p> <p>Length: 8" up to 120"</p> | <p>Page 54</p> |

* Maximum widths and lengths listed do not take into account square foot or weight limitations. Make sure to refer to shaded areas on price groups for maximum size availability by fabric style.

Cellular Shade Collection
HARDWARE OPTIONS

| | Key Features | Color Options | Hardware Size (Depth x Height) | Widths & Lengths* | More Information |
|--|--|--|--|---|----------------------------------|
| Ovation™ Slider  | <ul style="list-style-type: none"> Vertically oriented fabric glides across window Shade can stack left, right or center Great for sliding glass doors or room dividers | <ul style="list-style-type: none"> White (Standard) Ivory Tan Gray | 3 5/8" x 1 3/4" | Width: 12" up to 168" Length: 24" up to 120" | Page 64 |
| French Door Décor  | <ul style="list-style-type: none"> Great option for narrow windows and doors Available in moveable & non-moveable rails No Pull cords | <ul style="list-style-type: none"> Color Coordinated Fabric Wrapped Oil Rubbed Bronze | Standard Head Rail: 1 7/8" x 1/2" Deluxe Head Rail: 2 3/8" x 1/2" | Width: 6" up to 36" Length: 12" up to 96" | Page 82 |
| Insulating SlumberShade™  | <ul style="list-style-type: none"> Ultimate blackout shade Tracks keep out light, cold or heat Perfect for nurseries, day sleepers Available in Cord Lock, Cord Loop, Cordless and motorized | <ul style="list-style-type: none"> Color Coordinated Fabric Wrapped Oil Rubbed Bronze Sidetracks are available in white, tan or Bronze | Dependent on hardware choice | Width: 9" up to 96" Length: 8" up to 120" | Page 66 |
| Top Down-Bottom Up  | <ul style="list-style-type: none"> Lower shade from top: raise from bottom Great for privacy Ideal for light control Available in Cord Lock, Cord Loop, Cordless and motorized | <ul style="list-style-type: none"> Color Coordinated Fabric Wrapped Oil Rubbed Bronze | Dependent on hardware choice | Width: 18" up to 120" Length: 8" up to 120" | See Product Availability Page 12 |
| Two on One Head Rail  | <ul style="list-style-type: none"> Operate two shades on one rail Great for larger windows Individually operating shades | <ul style="list-style-type: none"> Color Coordinated Fabric Wrapped Oil Rubbed Bronze | Dependent on Style See Above | Width: 16" up to 144" Length: 8" up to 120" | See Product Availability Page 12 |

Maximum widths and lengths listed do not take into account square foot or weight limitations. Make sure to refer to shaded areas on price groups for maximum size availability by fabric style. Make sure to consult specification charts for specific fabric styles.

Cellular Shade Collection
FABRIC COLLECTIONS

| Fabric Collection | Cell Size and Structure | Opacities | Fabric Content |
|--------------------------|--|--|--|
| Debut* | <ul style="list-style-type: none"> • ½-Inch Single Cell • ¾-Inch Single Cell • ½-Inch Double Cell | <ul style="list-style-type: none"> • Light Filtering | <ul style="list-style-type: none"> • Light Filtering: Non-Woven Polyester |
| Premiere** | <ul style="list-style-type: none"> • ½-Inch • ¾-Inch • Single Cell | <ul style="list-style-type: none"> • Light Filtering • Blackout • Karma-Light Room Darkening | <ul style="list-style-type: none"> • Light Filtering: Non-Woven Polyester • Blackout: Opaque lining pressed between two layers of non-woven polyester • Karma-Light technology insures color on front fabric will not be distorted like traditional blackout shades. Opaque lining is used only on back side of the cells • Limited Blackout colors available, refer to www.comfortex.com |
| Symphony | <ul style="list-style-type: none"> • ¾-Inch • Double Cell | <ul style="list-style-type: none"> • Light Filtering • Flame Retardant Light Filtering • Blackout | <ul style="list-style-type: none"> • Light Filtering: Non-Woven Polyester • Blackout: Non-Woven Polyester with foil lining |

* Debut Light Filtering fabrics include solid colors, Homespun, Country Woven, Florance, Strata, Angel Hair, Blossom, Strie and Terrazzo.

** Premiere fabrics include the following prints: Spheres and Tuscan Scroll. Premiere Blackout fabrics include the following prints: Homespun, Country Woven, Florance, Strata, Angel Hair and Blossom.

Cellular Shade Collection

SIZE STANDARDS

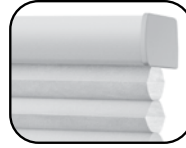
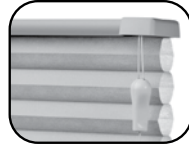

| | | | Cord Lock | | Cord Loop | | Cordless Ultra | | Cordless Lift & Lock | | |
|--|--|---|------------------------|---------------------------|-------------------------|---------------------------|---------------------------|---------------------------|---------------------------|-------------------------|-------------------------|
| Minimum | | | Bottom Up | Top Down Bottom Up | Bottom Up | Top Down Bottom Up | Bottom Up | Top Down Bottom Up | Bottom Up | Top Down Bottom Up | |
| ALL FABRICS | Minimum Width | | 8" | 12" | 14" | 22" | 15" OB or 15 3/8" IB | 18" OB or 18 3/8" IB | 16" OB or 16 3/8" IB | 20" OB or 20 3/8" IB | |
| | Min. Length | | 8" | 8" | 8" | 8" | 8" | 8" | 8" | 8" | |
| Light Filtering | Price Group | Page | Bottom Up | Top Down Bottom Up | Bottom Up | Top Down Bottom Up | Bottom Up | Top Down Bottom Up | Bottom Up | Top Down Bottom Up | |
| Debut Premiere Symphony 3/8" | 56 1 7 | 21-22 18 23 | Maximum Width & Length | 108" width 120" length | 96" width 96" length | 108" width 120" length | 108" width 120" length | 108" width 84" length | 96" width 84" length | 96" width 84" length | 96" width 84" length |
| | Refer to shaded area in price grids for max size (sq ft) by fabric style | | | | | | | | | | |
| Room Darkening & Blackout | Price Group | Page | Bottom Up | Top Down Bottom Up | Bottom Up | Top Down Bottom Up | Bottom Up | Top Down Bottom Up | Bottom Up | Top Down Bottom Up | |
| Premiere | 4 | 20 | Maximum Width & Length | 108" width 120" length | 84" width 96" length | 108" width 120" length | 108" width 120" length | 108" width 84" length | 96" width 84" length | 96" width 84" length | 96" width 84" length |
| | | | Symphony 3/8" | 8 | 24 | 120" width 120" length | 84" width 96" length | 120" width 120" length | 120" width 120" length | Not Available | 84" width 84" length |
| Refer to shaded area in price grids for max size (sq ft) by fabric style | | | | | | | | | | | |
| | | | Bottom Up | Top Down Bottom Up | Bottom Up | Top Down Bottom Up | Bottom Up | Top Down Bottom Up | Bottom Up | Top Down Bottom Up | |
| Stacking Heights Information On Page More Information On Page | | | Page 13 Page 44 | | Page 13 Page 46 | | Page 13 Page 48 | | Page 13 Page 50 | | |

NOTE: Cordlock: Please Note: For any shades under 12" width, the maximum height is 80".
Cordloop and cordless shades less than 24" in width are limited to 84" in length
Maximum width for side mount refer to hardware pages.

Cellular Shade Collection

SIZE STANDARDS



| | | | | Motorization | | Motorization | | Two-On-One Head Rail | |
|--------------------------------------|----|--------------------|--|------------------------|--|-------------------------|---------------|----------------------|--|
| Minimum | | | | Simplicity | Simplicity+ Rechargeable | PowerTouch Rechargeable | Cord Lock | Cord Loop/Cordless | |
| ALL FABRICS | | | | Min Width | 18" | 18" | 16" | 36" | |
| | | | | Min. Length | 8" | 8" | 8" | 8" | |
| Light Filtering | | | | Simplicity | Simplicity Rechargeable | PowerTouch Rechargeable | Cord Lock | Cord Loop/Cordless | |
| Price Group | | Page | | | | | | | |
| Debut | 56 | 21-22 | | Maximum Width & Length | 108" width | 108" width | 144" width | 144" width | |
| Premiere | 1 | 18 | | | 120" length** | 120" length** | 120" length | 120" length++ | |
| Symphony 3/8" | 7 | 23 | | | Refer to shaded area in price grids for max size (sq ft) by fabric style | | | | |
| Room Darkening & Blackout | | | | Simplicity | Simplicity Rechargeable | PowerTouch Rechargeable | Cord Lock | Cord Loop/Cordless | |
| Price Group | | Page | | | | | | | |
| Premiere | 4 | 20 | | Maximum Width & Length | 108" width | 108" width | 144" width | 144" width | |
| | | | | | 120" length** | 120" length** | 120" length | 120" length++ | |
| | | | | | Refer to shaded area in price grids for max size (sq ft) by fabric style | | | | |
| Symphony 3/8" | 8 | 24 | | 108" width | 108" width | 144" width | 144" width | | |
| | | | | 120" length** | 120" length** | 120" length | 120" length++ | | |
| | | | | Simplicity | Simplicity Rechargeable | PowerTouch Rechargeable | Cord Lock | Cord Loop/Cordless | |
| Stacking Heights Information On Page | | | | Page 13 | Page 13 | Page 13 | Page 13 | Page 13 | |
| More Information On Page | | | | Page 52 | Page 62 | | Page 12 | Page 12 | |

* Maximum widths and lengths listed do not take into account square foot or weight limitations. Make sure to refer to shaded areas on price groups for maximum size availability by fabric style. **Motorized shades less than 24" in width are limited to a maximum of 60" in length. +Simplicity Rechargeable Top Down-Bottom Up motorization minimum width is 24" IB and 23 3/8" OB. ++ Cordloop is 120", Cordless is 84" maximum length

Cellular Shade Collection

SIZE STANDARDS



| | | SlumberShade Cord Lock | | SlumberShade Cord Loop | | SlumberShade Cordless | | Motorization |
|-------------|---------------|------------------------|--------------------|------------------------|--------------------|-----------------------|--------------------|--------------------------|
| | | Bottom Up | Top Down Bottom Up | Bottom Up | Top Down Bottom Up | Bottom Up | Top Down Bottom Up | Simplicity+ Rechargeable |
| ALL FABRICS | Minimum Width | 9" | 13" | 15" | 25" | 16" IB | 19" | 19" |
| | Min. Length | 8" | 8" | 8" | 8" | 8" | 8" | 8" |

| | | | | SlumberShade Cord Lock | | SlumberShade Cord Loop | | SlumberShade Cordless | | Motorization |
|-----------------|-------------|--------------------|--|--------------------------|-------------------------|--------------------------|--------------------------|-------------------------|-------------------------|---------------------------|
| | | | | Bottom Up | Top Down Bottom Up | Bottom Up | Top Down Bottom Up | Bottom Up | Top Down Bottom Up | Simplicity+ Rechargeable |
| Light Filtering | Price Group | Page | Maximum Width & Length Refer to shaded area in price grids for max size (sq ft) by fabric style | | | | | | | |
| Debut | 5-6 | 21-22 | | 96" width 120" length | 96" width 96" length | 96" width 120" length | 96" width 120" length | 96" width 84" length | 96" width 84" length | 108" width 120" length |
| Premiere | 3 | 19 | | | | | | | | |
| Symphony 3/8" | 7 | 23 | | | | | | | | |

| | | | | SlumberShade Cord Lock | | SlumberShade Cord Loop | | SlumberShade Cordless | | Motorization |
|---------------------------|-------------|--------------------|--|--------------------------|-------------------------|--------------------------|--------------------------|---|-------------------------|---------------------------|
| | | | | Bottom Up | Top Down Bottom Up | Bottom Up | Top Down Bottom Up | Bottom Up | Top Down Bottom Up | Simplicity+ Rechargeable |
| Room Darkening & Blackout | Price Group | Page | Maximum Width & Length Refer to shaded area in price grids for max size (sq ft) by fabric style | | | | | | | |
| Premiere | 4 | 20 | | 96" width 120" length | 84" width 96" length | 96" width 120" length | 96" width 120" length | 96" width 84" length | 96" width 84" length | 108" width 120" length |
| Symphony 3/8" | 8 | 24 | | | | | | Symphony Blackout not available as cordless | | |

| | | | | SlumberShade Cord Lock | | SlumberShade Cord Loop | | SlumberShade Cordless | | Motorization |
|--|--|--|--|------------------------|--------------------|------------------------|--------------------|-----------------------|--------------------|--------------------------|
| | | | | Bottom Up | Top Down Bottom Up | Bottom Up | Top Down Bottom Up | Bottom Up | Top Down Bottom Up | Simplicity+ Rechargeable |
| Stacking Heights Information On Page More Information On Page | | | | Page 13 Page 66 | Page 13 Page 66 | Page 13 Page 66 | Page 13 Page 66 | Page 13 Page 66 | Page 13 Page 66 | |

* Maximum widths and lengths listed do not take into account square foot or weight limitations. Make sure to refer to shaded areas on price groups for maximum size availability by fabric style.

** Motorized shades less than 24" in width are limited to a maximum of 60" in length.

+Simplicity Rechargeable Top Down-Bottom Up motorization minimum width is 25" IB and 24 3/8" OB.

++ Cordloop is 120", Cordless is 84" maximum length

Ovation Cellular Slider Shade SIZE STANDARDS



| Ovation Cellular Slider | | |
|-------------------------|----------------|-----|
| Standard | | |
| ALL FABRICS | Minimum Width | 12" |
| | Minimum Length | 24" |

| Light Filtering | Price Group | Page | Ovation Cellular Slider | |
|--|-------------|--------------------|-------------------------|--------------|
| Debut 1/2" Single Debut 1/2" Double | 10 | 26 | Maximum Width & Length | 120"* x 108" |
| Symphony 3/8" Debut 3/4" Premiere 3/4" | 10 | 26 | Maximum Width & Length | 168"* x 108" |

| Room Darkening & Blackout | Price Group | Page | Ovation Cellular Slider | |
|---------------------------|-------------|--------------------|-------------------------|--------------|
| Premiere 3/4" | 11 | 27 | Maximum Width & Length | 168"* x 108" |

Maximum Square Footage Side=100"
 Split=140"

| More Information On Page | | Ovation Cellular Slider |
|--------------------------|--|-------------------------|
| | | Page 64 |

- * Split stack sliders are available in widths up to 240"; however, if the width exceeds 120", it will be fabricated as two separate sliders. The supplied valance will create the appearance of a single slider.
- ** Split stack sliders are available to 336", however if the width exceeds 168", the shade will be fabricated as two separate sliders. Supplied valance will create the appearance of a single slider. Please call customer service for assistance.
- *** Prelude split stack can go up to 190" wide on one head rail.

Speciality Shaped Shades

SIZE STANDARDS

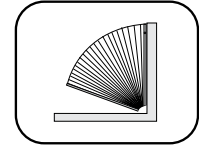
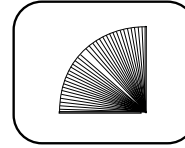
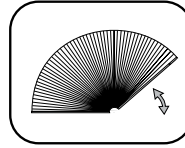
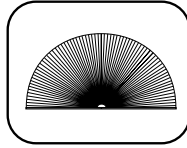

| | | Starburst Non-Movable Arch | Starburst Movable Arch | Quarter Round Non-Movable | Quarter Round Movable |
|-----------------------------------|----------------|----------------------------|------------------------|---------------------------|-----------------------|
| ALL FABRICS (except 3/4" Prelude) | Minimum Width | 18" | 18" | 9" | 9" |
| | Minimum Length | 9" | 9" | 9" | 9" |

| Light Filtering | Price Group | Page | | Starburst Non-Movable Arch | Starburst Movable Arch | Quarter Round Non-Movable | Quarter Round Movable |
|-------------------|-------------|--------------------|------------------------|----------------------------|------------------------|---------------------------|-----------------------|
| Debut 1/2" Double | 12 | 28 | Maximum Width & Length | 60" x 48" | 72" x 36" | 48" x 48" | 48" x 48" |
| Debut 1/2" Single | | | | 60" x 48" | 72" x 36" | 52" x 52" | 48" x 48" |
| Debut 3/4" | | | | 60" x 48" | 72" x 36" | 48" x 48" | 48" x 48" |
| Premiere 1/2" | | | | 60" x 48" | 72" x 36" | 48" x 48" | 48" x 48" |
| Premiere 3/4" | | | | 72" x 36" | 72" x 36" | 48" x 48" | 48" x 48" |
| Symphony 3/8" | | | | 96" x 48" | 72" x 36" | 52" x 52" | 48" x 48" |

| Room Darkening & Blackout | Price Group | Page # | | Starburst Non-Movable Arch | Starburst Movable Arch | Quarter Round Non-Movable | Quarter Round Movable |
|---------------------------|-------------|--------------------|------------------------|----------------------------|------------------------|---------------------------|-----------------------|
| Premiere 1/2" | 13 | 29 | Maximum Width & Length | 60" x 48" | 72" x 36" | 48" x 48" | 48" x 48" |
| Premiere 1/2" | | | | 60" x 48" | 72" x 36" | 48" x 48" | 48" x 48" |
| Premiere 3/4" | | | | 72" x 36" | 72" x 36" | 48" x 48" | 48" x 48" |
| Symphony 3/8" | | | | 96" x 48" | 72" x 36" | 52" x 52" | 48" x 48" |

| | Starburst Non-Movable Arch | Starburst Movable Arch | Quarter Round Non-Movable | Quarter Round Movable |
|--------------------------|----------------------------|------------------------|---------------------------|-----------------------|
| More Information On Page | Page 68 | Page 68 | Page 71 | Page 71 |

NOTE: Starburst Movable Arches are available as inside mount only. Through our maximum width is 84" and our maximum is 72" on Sunset Arches, there are limitations on some larger sizes due to excessive weight. If the Sunset width exceeds 66", the maximum length is 60". If the Sunset width exceeds 72", the maximum length is 48".

Speciality Shaped Shades

SIZE STANDARDS

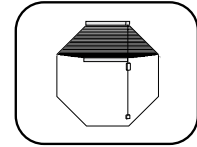
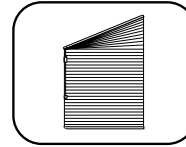
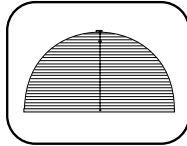

| | | Sunset Arch | Trapezoid | Octagon |
|--------------------------------------|----------------|-------------|-----------|---------|
| ALL FABRICS (except 3/4" Prelude) | Minimum Width | 18" | 12" | 12" |
| | Minimum Length | 6" | 12" | 12" |

| Light Filtering | Price Group | Page | | Sunset Arch | Price Group | Page | Trapezoid | Octagon |
|-------------------|-------------|--------------------|------------------------|--------------|-------------|------|-----------|-----------|
| Debut 1/2" Double | 14 | 30 | Maximum Width & Length | 84" x 72"*** | 16 | 32 | 60" x 72" | 48" x 48" |
| Debut 1/2" Single | | | | 84" x 72"*** | | | 60" x 72" | 48" x 48" |
| Debut 3/4" | | | | 84" x 72"*** | | | 60" x 72" | 48" x 48" |
| Premiere 1/2" | | | | 84" x 72"*** | | | 60" x 72" | 48" x 48" |
| Premiere 3/4" | | | | 84" x 72"*** | | | 48" x 72" | 48" x 48" |
| Symphony 3/8" | | | | 84" x 72"*** | | | 60" x 72" | 48" x 48" |

| Room Darkening & Blackout | Price Group | Page | | Sunset Arch | Price Group | Page | Trapezoid | Octagon |
|---------------------------|-------------|--------------------|------------------------|-------------|-------------|------|-----------|-----------|
| Premiere 1/2" | 15 | 31 | Maximum Width & Length | 60" x 60" | 16 | 32 | 48" x 72" | 48" x 48" |
| Premiere 3/4" | | | | 60" x 60" | | | 48" x 72" | 48" x 48" |
| Symphony 3/8" | | | | NA | | | 60" x 72" | 48" x 48" |

| | Sunset Arch | Trapezoid | Octagon |
|--------------------------|-------------|-----------|---------|
| More Information On Page | Page 69 | Page 73 | Page 73 |

NOTE: Through our maximum width is 84" and our maximum is 72" on Sunset Arches, there are limitations on some larger sizes due to excessive weight. If the Sunset width exceeds 66", the maximum length is 60". If the Sunset width exceeds 72", the maximum length is 48".

*Max width of trapezoid refers to max width of the top rail.

Comfortex Skylight and Greenhouse Shades

SIZE STANDARDS

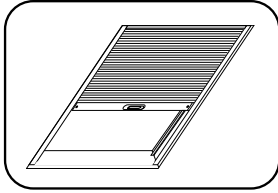

| | Minimum | Balcony* 0°-15° 15°-75° 75°-90°** | Soprano*** Skylight/Greenhouse | Mezzo |
|--------------------|------------|--|-----------------------------------|-------|
| ALL FABRICS | Min Width | 15" | 11" | 18" |
| | Min Length | 12" | 11" | 12" |

| Light Filtering | Price Group Page | Max Width & Length | Balcony* | | | | | Price Group Page | Mezzo | Price Group Page |
|------------------------|------------------|--------------------|-----------|-----------|-----------|------------------|---------------------|------------------|-----------|------------------|
| | | | 0°-15° | 15°-75° | 75°-90°** | Soprano Skylight | Soprano Greenhouse+ | | | |
| Debut ½" Double | Grid 20 Page 35 | Max Width & Length | NA | NA | NA | NA | NA | Grid 18 Page 34 | 48" x 72" | Grid 22 Page 37 |
| Debut ½" Single | | | 36" x 96" | 48" x 96" | 48" x 72" | 36" x 144" | 29" x 180" | | 48" x 72" | |
| Debut ¾" | | | 36" x 96" | 48" x 96" | 48" x 72" | 48" x 72" | 29" x 180" | | 48" x 72" | |
| Premiere ½" | | | NA | NA | NA | NA | NA | | 48" x 72" | |
| Premiere ¾" | | | 36" x 96" | 48" x 96" | 48" x 72" | 48" x 72" | 36" x 180" | | 48" x 72" | |
| Symphony ¾" | | | 36" x 96" | 48" x 96" | 48" x 72" | 48" x 144" | 36" x 180" | | 48" x 72" | |

| Room Darkening & Blackout | Price Group Page | Max Width & Length | Balcony* | | | | | Price Group Page | Mezzo | Price Group Page |
|---------------------------|------------------|--------------------|-----------|-----------|-----------|------------------|---------------------|------------------|-----------|------------------|
| | | | 0°-15° | 15°-75° | 75°-90°** | Soprano Skylight | Soprano Greenhouse+ | | | |
| Premiere ½" | Grid 21 Page 36 | Max Width & Length | NA | NA | NA | NA | NA | NA | 48" x 72" | Grid 23 Page 38 |
| Premiere ¾" | | | 36" x 96" | 48" x 96" | 48" x 72" | 48" x 72" | 36" x 180" | | 48" x 72" | |
| Symphony ¾" | | | 36" x 96" | 48" x 96" | 48" x 72" | NA | NA | | 48" x 72" | |

| | | | |
|--------------------------|---------|---------|---------|
| More Information On Page | Page 77 | Page 75 | Page 79 |
|--------------------------|---------|---------|---------|

*Total Balcony shade area not to exceed 24 square feet. **Total Balcony shade area not to exceed 18 square feet. Balcony shades can be mounted on their side. Use vertical measurement as your width (max 36") and the horizontal measurement as your length (max 48"). ***Soprano Skylight minimum installation angle of 5 degrees. Maximum installation angle of 85 degrees. Horizontal (0 degrees) and vertical (90 degrees) applications are not recommended. +All Soprano Greenhouse shade orders require a completed and signed greenhouse shade order form. Orders must be faxed to Comfortex for processing. Download a copy of the order form at www.comfortex.com/comfortex-dealers.

Soprano Greenhouse shades are available in ¾" Symphony light filtering and Debut ½" light filtering only.

French Door Décor Shades

SIZE STANDARDS

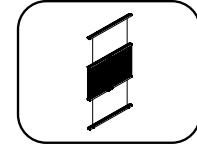
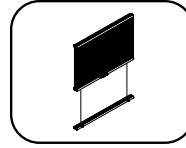
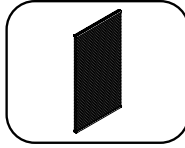

| | | Door Decor Non-Movable | Door Decor Movable | | Door Decor Top Down-Bottom Up |
|-------------|----------------|------------------------|--------------------|--|-------------------------------|
| ALL FABRICS | Minimum Width | 6" | 6" | | 6" |
| | Minimum Length | 12" | 12" | | 12" |

| Light Filtering | Price Group | Page | | Door Decor Non-Movable | Door Decor Movable | Price Group Page | Door Decor Top Down-Bottom Up | Price Group Page |
|-------------------|-------------|------|------------------------|------------------------|--------------------|------------------|-------------------------------|------------------|
| Debut 1/2" Single | 24 | 39 | Maximum Width & Length | 36" x 96" | 36" x 96" | 25 Page 40 | 36" x 96" | 25 Page 40 |
| Debut 1/2" Double | | | | 36" x 96" | 36" x 96" | | 36" x 96" | |
| Debut 3/4" | | | | 36" x 96" | 36" x 96" | | 36" x 96" | |
| Premiere 1/2" | | | | 36" x 96" | 36" x 96" | | 36" x 96" | |
| Premiere 3/4" | | | | 36" x 96" | 36" x 96" | | 36" x 96" | |
| Symphony 3/8" | | | | 36" x 96" | 36" x 96" | | 36" x 96" | |

| Room Darkening & Blackout | Price Group Page | Page | | Door Decor Non-Movable | Door Decor Movable | Price Group Page | Door Decor Top Down-Bottom Up | Price Group Page |
|---------------------------|------------------|------|------------------------|------------------------|--------------------|------------------|-------------------------------|------------------|
| Premiere 1/2" | 26 | 41 | Maximum Width & Length | 36" x 96" | 36" x 96" | 27 Page 42 | 36" x 96" | 27 Page 42 |
| Premiere 3/4" | | | | 36" x 96" | 36" x 96" | | 36" x 96" | |
| Symphony 3/8" | | | | 36" x 96" | 36" x 96" | | 36" x 96" | |

| | Door Decor Non-Movable | Door Decor Movable | Door Decor Top Down-Bottom Up |
|--------------------------|------------------------|--------------------|-------------------------------|
| More Information On Page | Page 82 | Page 82 | Page 82 |

Cellular Shade Collection

HARDWARE OPTION AVAILABILITY

Use this table to ensure your coordinating options and unique shapes are consistent with your product selections.

| STANDARD CORD LOCK | Premiere 3/4" LF & RD | Symphony Light Filtering | Symphony Blackout | Debut 1/2" Light Filtering | Debut 3/4" Light Filtering | Debut Double Cell Light Filtering |
|--|-----------------------------|--------------------------------|----------------------|-------------------------------------|-------------------------------------|--|
| Standard Cord Lock | • | • | • | • | • | • |
| Top Down-Bottom Up | • | • | • | • | • | • |
| Two-On-One Head Rail | • | • | • | • | • | • |
| Day-Night | • | • | • | • | • | • |
| CORD LOOP | | | | | | |
| Cord Loop | • | • | • | • | • | • |
| Cord Loop Top Down-Bottom Up | • | • | • | • | • | • |
| Cord Loop Two-On-One Head Rail | • | • | • | • | • | • |
| CORDLESS ULTRA | | | | | | |
| Cordless Ultra | • | • | - | • | • | • |
| Cordless Two-On-One Head Rail | • | • | - | • | • | • |
| Cordless Ultra Top Down-Bottom Up | • | • | - | • | • | • |
| CORDLESS LIFT & LOCK | | | | | | |
| Cordless Lift & Lock | • | • | • | • | • | • |
| Cordless Lift & Lock Two-On-One Head Rail | • | • | • | • | • | • |
| Cordless Lift & Lock Top Down-Bottom Up | • | • | • | • | • | • |
| MOTORIZATION | | | | | | |
| Simplicity Motorization | • | • | • | • | • | • |
| Simplicity Rechargeable Motorization | • | • | • | • | • | • |
| PowerTouch™ Rechargeable | • | • | • | • | • | • |
| Top Down-Bottom Up | • | • | • | • | • | • |
| INSULATING SLUMBERSHADES | | | | | | |
| Cord Lock | • | • | • | • | • | • |
| Cord Lock Top Down-Bottom Up | • | • | • | • | • | • |
| Cordless Ultra | • | • | - | • | • | • |
| Cordless Ultra Top Down-Bottom Up | • | • | - | • | • | • |
| Cord Loop | • | • | • | • | • | • |
| Cord Loop Top Down-Bottom Up | • | • | • | • | • | • |
| Simplicity Motorization | • | • | • | • | • | • |
| Simplicity Rechargeable Motorization | • | • | • | • | • | • |
| SKYLIGHTS AND SPECIALTY SHAPES | | | | | | |
| Balcony Shading System | • | • | • | • | • | - |
| French Door Decor | • | • | • | • | • | • |
| Mezzo Motorized Skylights | • | • | • | • | • | • |
| Octagon | • | • | • | • | • | • |
| Ovation Cellular Slider | ••• | • | - | • | • | • |
| Quarter Round - Moveable | • | • | • | • | • | • |
| Quarter Round - Non-Movable | • | • | • | • | • | • |
| Soprano Skylights | • | • | - | • | • | - |
| Soprano Greenhouses | - | • | - | • | - | - |
| Starburst Arch - Movable | • | • | • | • | • | • |
| Starburst Arch - Non-Movable | • | • | • | • | • | • |
| Sunset Arch - Moveable | • | • | - | • | • | • |
| Trapezoid | • | • | • | • | • | • |

••• 3/4" Premiere fabrics only

Cellular Shade Collection

SHADE STACK HEIGHTS

Measurements are in inches. Shade stacking heights applicable when the shade is in the fully raised position.

| RECTANGULAR CORD LOCK - Includes head and bottom rails | 48" | 72" | 84" | 96" | 108" | 120" |
|---|------------|------------|------------|------------|-------------|-------------|
| Debut 1/2" Double Cell Light Filtering | 1 1/2" | 1 5/8" | 1 3/4" | 1 7/8" | 2 | 2 1/8" |
| Debut 1/2" Single Cell Light Filtering | 1 3/8" | 2 3/4" | 3" | 3 3/8" | 3 5/8" | 4 |
| Debut 3/4" Single Cell Light Filtering | 1 1/2" | 1 5/8" | 1 3/4" | 1 7/8" | 2 | 2 1/8" |
| Premiere 1/2" Single Cell Blackout | 2" | 2 1/2" | 2 5/8" | 2 7/8" | 3 1/8" | 3 1/4" |
| Premiere 1/2" Single Cell Light Filtering | 1 7/8" | 2 1/4" | 2 1/2" | 2 5/8" | 2 7/8" | 3 |
| Premiere 3/4" Single Cell Blackout | 2" | 2 3/8" | 2 5/8" | 2 3/4" | 3 | 3 1/8" |
| Premiere 3/4" Single Cell Light Filtering | 1 3/4" | 2 1/8" | 2 1/4" | 2 3/8" | 2 1/2" | 2 5/8" |
| Symphony 3/8" Double Cell Blackout | 2" | 2 1/2" | 2 3/4" | 3" | 3 1/4" | 3 1/2" |
| Symphony 3/8" Double Cell Light Filtering | 2 1/4" | 2 3/4" | 3" | 3 1/4" | 3 1/2" | 3 3/4" |
| CORD LOOP - CORDLESS ULTRA - MOTORIZATION - Includes head and bottom rails | 48" | 72" | 84" | 96" | 108" | 120" |
| Debut 1/2" Double Cell Light Filtering | 2 1/2" | 2 5/8" | 2 3/4" | 2 7/8" | 3 | 3 1/8" |
| Debut 1/2" Single Cell Light Filtering | 3 1/4" | 3 3/4" | 4" | 4 3/8" | 4 5/8" | 5 |
| Debut 3/4" Single Cell Light Filtering | 2 1/2" | 2 5/8" | 2 3/4" | 2 7/8" | 3 | 3 1/8" |
| Premiere 1/2" Single Cell Blackout | 3" | 3 1/2" | 3 5/8" | 3 7/8" | 4 1/8" | 4 1/4" |
| Premiere 1/2" Single Cell Light Filtering | 2 7/8" | 3 1/4" | 3 1/2" | 3 5/8" | 3 7/8" | 4 |
| Premiere 3/4" Single Cell Blackout | 3" | 3 3/8" | 3 5/8" | 3 3/4" | 4 | 4 1/8" |
| Premiere 3/4" Single Cell Light Filtering | 2 3/4" | 3 1/8" | 3 1/4" | 3 3/8" | 3 1/2" | 3 5/8" |
| Symphony 3/8" Double Cell Blackout | 2 7/8" | 3 3/8" | 3 5/8" | 3 7/8" | 4 1/2" | 4 3/4" |
| Symphony 3/8" Double Cell Light Filtering | 3 1/8" | 3 1/2" | 3 3/4" | 3 7/8" | 4 1/8" | 4 1/4" |

For Top Down-Bottom Up, add 5/8"

| CORDLESS LIFT & LOCK - Includes head and bottom rails | 48" | 60" | 72" | 84" | 108" | 120" |
|--|------------|------------|------------|------------|-------------|-------------|
| Debut 1/2" Double Cell Light Filtering | 2 1/4" | 2 3/8" | 2 1/2" | 2 5/8" | 2 3/4" | 2 7/8" |
| Debut 1/2" Single Cell Light Filtering | 3" | 3 1/2" | 3 3/4" | 4 1/8" | 4 3/8" | 4 3/4" |
| Debut 3/4" Single Cell Light Filtering | 2 1/4" | 2 3/8" | 2 1/2" | 2 5/8" | 2 3/4" | 2 7/8" |
| Premiere 1/2" Single Cell Blackout | 2 3/4" | 3 1/4" | 3 3/8" | 3 5/8" | 3 7/8" | 4 |
| Premiere 1/2" Single Cell Light Filtering | 2 5/8" | 3 3/4" | 3 1/4" | 3 5/8" | 3 1/2" | 3 1/2" |
| Premiere 3/4" Single Cell Blackout | 2 3/4" | 3 1/8" | 3 3/8" | 3 1/2" | 3 3/4" | 3 7/8" |
| Premiere 3/4" Single Cell Light Filtering | 2 1/4" | 2 7/8" | 3" | 3 1/8" | 3 3/8" | 3 1/2" |
| Symphony 3/8" Double Cell Blackout | 2 3/4" | 3 1/4" | 3 1/2" | NA | NA | NA |
| Symphony 3/8" Double Cell Light Filtering | 3" | 3 1/2" | 3 3/4" | 4" | 4 1/4" | 4 1/2" |

For Top Down-Bottom Up, add 1 1/4"

| OVATION | 84" | 96" | 108" | 120" |
|----------------|------------|------------|-------------|-------------|
| All Fabrics | 6 1/2" | 7 1/4" | 8" | 8 3/4" |

Ovations minimum fabric stack measures 6 1/2" regardless of the ordered width. Fabric stacking dimensions are determined by the slider's hardware, not ordered width.

Cellular Shade Collection
SHADE STACK HEIGHTS

Cellular Shade Pricing Examples

Rechargeable Simplicity Pricing Example:

| | |
|--|-----------------|
| Debut 1/2" | |
| Light Filtering 42" x 60" Shade: | \$417.00 |
| Simplicity Rechargeable Motor Surcharge: | \$300.00 |
| Charger for Rechargeable: | \$30.00 |
| 14 Channel Remote Control: | \$50.00 |
| Total List Price: | \$797.00 |

Motorized Top Down-Bottom Up Pricing Example:

| | |
|---|------------------|
| Debut 1/2" | |
| Light Filtering 42" x 60" Shade: | \$417.00 |
| Simplicity Rechargeable TDBU Surcharge: | \$515.00 |
| Charger for Rechargeable: | \$30.00 |
| TDBU Remote Control: | \$50.00 |
| Total List Price: | \$1012.00 |

Cordless Ultra Simplicity Pricing Example:

| | |
|----------------------------------|-----------------|
| Debut 1/2" | |
| Light Filtering 42" x 60" Shade: | \$417.00 |
| Cordless Ultra Surcharge: | \$108.00 |
| Scotchgard: | \$48.00 |
| Total List Price: | \$573.00 |

Simplicity Motorization Pricing Example:

| | |
|----------------------------------|-----------------|
| Debut 1/2" | |
| Light Filtering 42" x 60" Shade: | \$417.00 |
| Simplicity Motor Surcharge: | \$300.00 |
| 14 Channel Remote Control: | \$50.00 |
| Total List Price: | \$767.00 |

Cellular Shade Collection

HARDWARE UPGRADE OPTIONS

| LIFT SYSTEM | UPGRADES | ADD | DESIGNER UPGRADE OPTIONS | UPGRADES | ADD |
|--------------------------|-----------------------------------|---|--|---|---|
| Cord Lock | Top Down-Bottom Up | \$85 | Add to Any Lift System Upgrade <i>(Chart to the left)</i> | Metallic Hardware | \$30 |
| | Cordless Lift & Lock | Bottom Up | | No extra charge | Fabric Wrapped Hardware |
| Cordless Ultra | Top Down-Bottom Up | \$108 | | Scotchgard Stain Protection <i>(Not available on Prelude)</i> <i>See Page 91 For More Information</i> | \$48 |
| | Bottom Up | \$108 | | Slumbershade Light Blocking Sidetrack System | Insulating SlumberShades <i>See Page 66 For More Information</i> |
| Cord Loop | Top Down-Bottom Up | \$215 | | | |
| | Bottom Up | \$108 | | | |
| | Top Down-Bottom Up | \$215 | | | |
| ADDITIONAL OPTIONS | UPGRADES | ADD | | | |
| Add to Any Upgrade Above | Two-On-One Head Rail | Price each panel as a separate shade, including lift system upgrades, add together, then add \$66 | | | |
| | Three-On-One Head Rail | Price each panel as a separate shade, including lift system upgrades, add together | | | |
| | Cut Outs | \$69 Per side. See page 94 for more information | | | |
| | Day-Night | Price each separate shade then add together | | | |
| Other | Soprano - Two Moving Rails | \$169 | | | |
| | Ovation Center Stack | \$108 | | | |
| Accessories | 3 Foot Expandable Pole - Silver | \$30 | | | |
| | 5-10 Foot Expandable Pole - Black | \$54 | | | |

Cellular Shade **Motorized** Hardware Upgrade Options

| MOTORIZED | UPGRADES | ADD | |
|---|---|-------|---|
| 7.4V PowerTouch Rechargeable Motorization System | Rechargeable Integrated Battery Pack | \$100 | For More Information Page 62 |
| | Plug-In Charger for Rechargeable Li-Ion | \$30 | |
| 12V Simplicity Motorization System <i>(non-rechargeable)</i> | Motor and Battery Wand | \$300 | For More Information Page 60 |
| | 48" Extension Wire | \$10 | |
| | Single Unit DC Power Supply/Transformer | \$30 | |
| 7.4V Simplicity Rechargeable Motorization System | Motor and Integrated Battery Pack | \$300 | For More Information Page 54 |
| | Plug-In Charger for Rechargeable Li-Ion | \$30 | |
| | Top Down-Bottom Up* | \$515 | |
| | 7.4v Solar Panel & Mounting Brackets | \$120 | |
| Simplicity Systems Controllers | NEO Controller | \$280 | For More Information Pages 61, 56 & 58 |
| | NEO App for Mobile Devices | FREE | |
| | Simplicity 14 Channel White Remote ** | \$50 | |
| EZ Charge Extension Wand 7.4V Rechargeable Motors | Wall Mount Receiver Kit 7.4V | \$18 | For More Information Page 59 |
| | Extendable Wand 7.4V | \$32 | |
| 12V Low Voltage Hardwiring <i>(Not available on Prelude)</i> | 9 Channel Wall Mount Transformer 12V | \$232 | For More Information Page 60 |

*Upcharge includes motorization plus second motor and Top Down-Bottom Up components
** Simplicity 14 channel remote is TDBU capable and is required for Motorized Top Down-Bottom Up shades

Cellular Shade Collection

PRICING GRIDS



1 Cord Lock | Cordless Lift & Lock
Premiere 1/2" Light Filtering



2 Cord Lock | Cordless Lift & Lock
Premiere 1/2" Blackout



3 Cord Lock | Cordless Lift & Lock
Premiere 3/4" Light Filtering



4 Cord Lock | Cordless Lift & Lock
Premiere 3/4" Karma-Light
Room Darkening & Blackout



5 Cord Lock | Cordless Lift & Lock
Debut 1/2" Single Cell



6 Cord Lock | Cordless Lift & Lock
Debut 3/4" Single Cell
Debut 1/2" Double Cell



7 Cord Lock | Cordless Lift & Lock
Symphony 3/8" Light Filtering



8 Cord Lock | Cordless Lift & Lock
Symphony 3/8" Blackout



9 SlumberShade Fabric
Premiere 3/4" Blackout



10 Ovation Cellular Slider
Debut 1/2" | Debut 1/2" Double Cell
Debut 3/4" | Premiere 3/4"
Symphony 3/8" | Virtuoso 1/2"



11 Ovation Cellular Slider
Premiere 3/4" Blackout



12 Starburst Arches | Quarter Rounds
Light Filtering
Debut 1/2" Single Cell | Debut 1/2" Double Cell
Debut 3/4" Single Cell | Premiere 1/2" | Premiere 3/4"
Symphony 3/8" Double Cell



13 Starburst Arches | Quarter Rounds
Room Darkening & Blackout
Premiere 1/2" | Premiere 3/4"
Symphony 3/8" Double Cell



1 Sunset Movable Arches Light Filtering
Debut 1/2" Single Cell | Debut 1/2" Double Cell
Debut 3/4" Single Cell | Premiere 1/2"
Premiere 3/4" | Symphony 3/8" Double Cell



15 Sunset Movable Arches
Room Darkening & Blackout Fabrics
Premiere 1/2" | Premiere 3/4"



16 Trapezoids and Octagons Light Filtering
Debut 1/2" Single Cell | Debut 1/2" Double Cell
Debut 3/4" Single Cell | Premiere 1/2"
Premiere 3/4" | Symphony 3/8" Double Cell



17 Trapezoids and Octagons
Room Darkening & Blackout Fabrics
Premiere 1/2" | Premiere 3/4" | Symphony 3/8"



18 Soprano Skylights Light Filtering
Debut 1/2" Single Cell | Debut 3/4" Single Cell
Premiere 3/4" | Symphony 3/8" Double Cell



19 Soprano Skylights Room Darkening
Premiere 3/4"



20 Balcony Skylight Shading System
Light Filtering
Debut 1/2" Single Cell | Debut 3/4" Single Cell
Premiere 3/4" | Symphony 3/8" Double Cell

Cellular Shade Collection

PRICING GRIDS



21 Balcony Skylight Shading System
Blackout Fabrics
Premiere 3/4" | Symphony 3/8" Double Cell



25 Movable French Door Decor Light Filtering
Debut 1/2" Single Cell | Debut 1/2" Double Cell
Debut 3/4" Single Cell | Premiere 1/2"
Premiere 3/4" | Symphony 3/8"



22 Mezzo Motorized Skylights - White Rail
& Tracks Light Filtering
Debut 1/2" Single Cell | Debut 1/2" Double Cell
Debut 3/4" Single Cell | Premiere 1/2"
Premiere 3/4" | Symphony 3/8"



26 Non-Movable French Door Decor
Room Darkening & Blackout
Premiere 1/2" | Premiere 3/4" | Symphony 3/8"



23 Mezzo Motorized Skylights - White Rail
& Tracks Room Darkening & Blackout
Premiere 1/2" | Premiere 3/4" | Symphony 3/8"



27 Movable French Door Decor
Room Darkening & Blackout
Premiere 1/2" | Premiere 3/4" | Symphony 3/8"



24 Non-Movable French Door Decor
Light Filtering
Debut 1/2" Single Cell | Debut 1/2" Double Cell
Debut 3/4" Single Cell | Premiere 1/2" | Premiere 3/4"
| Symphony 3/8" Double Cell



Cellular Shade Collection

HARDWARE UPGRADE OPTIONS

Premiere 1/2" Light Filtering

PRICE GROUP 1

Cord Lock

Cordless Lift & Lock

| | | Width In Inches | | | | | | | | | | | |
|------------------|-----|-----------------|-----|-----|-----|------|------|------|------|------|------|------|------|
| | | 24 | 30 | 36 | 42 | 48 | 54 | 60 | 66 | 72 | 84 | 96 | 108 |
| Length In Inches | 36 | 216 | 239 | 276 | 305 | 338 | 368 | 398 | 426 | 456 | 524 | 586 | 654 |
| | 42 | 229 | 263 | 294 | 330 | 368 | 399 | 435 | 467 | 505 | 578 | 648 | 723 |
| | 48 | 242 | 280 | 321 | 357 | 398 | 434 | 472 | 511 | 552 | 642 | 735 | 825 |
| | 54 | 261 | 297 | 341 | 381 | 427 | 467 | 519 | 568 | 619 | 723 | 825 | 926 |
| | 60 | 277 | 321 | 368 | 409 | 454 | 519 | 577 | 630 | 690 | 803 | 917 | 1032 |
| | 66 | 292 | 338 | 387 | 443 | 506 | 568 | 630 | 695 | 758 | 882 | 1007 | 1133 |
| | 72 | 305 | 352 | 409 | 484 | 552 | 619 | 690 | 758 | 825 | 964 | 1099 | 1235 |
| | 78 | 321 | 376 | 450 | 524 | 597 | 671 | 746 | 820 | 894 | 1041 | 1190 | 1338 |
| | 84 | 329 | 405 | 484 | 564 | 642 | 723 | 803 | 882 | 964 | 1122 | 1281 | 1442 |
| | 90 | 345 | 432 | 519 | 605 | 690 | 774 | 861 | 946 | 1032 | 1204 | 1372 | 1543 |
| | 96 | 371 | 461 | 552 | 642 | 735 | 825 | 917 | 1007 | 1099 | 1281 | 1463 | 1645 |
| | 108 | 414 | 519 | 619 | 723 | 825 | 926 | 1032 | 1133 | 1235 | 1442 | 1645 | 1849 |
| 120 | 461 | 577 | 690 | 803 | 917 | 1032 | 1147 | 1257 | 1372 | 1600 | 1826 | 2057 | |

■ Cord Loop Hardware is recommended on sizes within the shaded area.
Motorized Lift Systems are not offered within the shaded area.

Premiere 1/2" Blackout

PRICE GROUP 2

Cord Lock

Cordless Lift & Lock

| | | Width In Inches | | | | | | | | | | | |
|------------------|-----|-----------------|-----|------|------|------|------|------|------|------|------|------|------|
| | | 24 | 30 | 36 | 42 | 48 | 54 | 60 | 66 | 72 | 84 | 96 | 108 |
| Length In Inches | 36 | 280 | 310 | 358 | 398 | 438 | 476 | 518 | 552 | 592 | 680 | 763 | 849 |
| | 42 | 298 | 342 | 381 | 429 | 476 | 518 | 567 | 607 | 656 | 751 | 844 | 942 |
| | 48 | 315 | 365 | 417 | 464 | 518 | 565 | 613 | 664 | 718 | 836 | 953 | 1073 |
| | 54 | 339 | 386 | 443 | 496 | 555 | 607 | 674 | 739 | 808 | 942 | 1073 | 1204 |
| | 60 | 359 | 415 | 476 | 532 | 589 | 674 | 749 | 819 | 895 | 1044 | 1191 | 1341 |
| | 66 | 376 | 438 | 505 | 577 | 658 | 739 | 819 | 904 | 983 | 1147 | 1309 | 1473 |
| | 72 | 398 | 457 | 532 | 630 | 718 | 808 | 895 | 983 | 1073 | 1253 | 1427 | 1606 |
| | 78 | 417 | 489 | 584 | 680 | 775 | 871 | 970 | 1066 | 1161 | 1354 | 1548 | 1741 |
| | 84 | 428 | 525 | 630 | 732 | 836 | 942 | 1044 | 1147 | 1253 | 1459 | 1666 | 1874 |
| | 90 | 448 | 562 | 674 | 786 | 895 | 1006 | 1118 | 1230 | 1341 | 1565 | 1784 | 2007 |
| | 96 | 482 | 601 | 718 | 836 | 953 | 1073 | 1191 | 1309 | 1427 | 1666 | 1902 | 2139 |
| | 108 | 539 | 674 | 808 | 942 | 1073 | 1204 | 1341 | 1473 | 1606 | 1874 | 2139 | 2404 |
| 120 | 601 | 749 | 895 | 1044 | 1191 | 1341 | 1490 | 1632 | 1784 | 2082 | 2374 | 2674 | |

■ Cord Loop Hardware is recommended on sizes within the shaded area.
Motorized Lift Systems are not offered within the shaded area.

| DESIGNER UPGRADE OPTIONS (Add to any Lift System Upgrade On Page 15) | | ADD |
|--|--|---|
| Metallic Hardware or Fabric Wrapped Hardware | | \$30 |
| Scotchgard Stain Protection (Not available on Prelude) | | \$48 |
| MOTORIZATION* OPTIONS | | MORE INFO |
| For additional options and surcharges refer to page 15. | | Pg 15 |
| ADDITIONAL OPTIONS | | MORE INFO |
| Prints & Custom Graphics | | Add 20% - Includes Anna Cote, Gradients, Spheres, Tuscan Scroll and Custom Graphics |
| For additional options and surcharges refer to page 15. | | Pg 15 |



*Motorized Pricing Examples pages 14, 53, 55 and 58

Cellular Shade Collection
PRICING

Premiere 3/4" Light Filtering

PRICE GROUP 3
Cord Lock
Cordless Lift & Lock

| | | Width In Inches | | | | | | | | | | | |
|------------------|-----|-----------------|-----|-----|------|------|------|------|------|------|------|------|------|
| | | 24 | 30 | 36 | 42 | 48 | 54 | 60 | 66 | 72 | 84 | 96 | 108 |
| Length In Inches | 36 | 238 | 264 | 304 | 336 | 372 | 405 | 438 | 468 | 502 | 578 | 646 | 720 |
| | 42 | 252 | 291 | 323 | 363 | 405 | 439 | 481 | 514 | 556 | 637 | 715 | 797 |
| | 48 | 267 | 309 | 354 | 394 | 438 | 480 | 520 | 564 | 608 | 709 | 810 | 909 |
| | 54 | 287 | 327 | 376 | 422 | 469 | 514 | 571 | 627 | 683 | 797 | 909 | 1022 |
| | 60 | 305 | 352 | 405 | 451 | 501 | 571 | 636 | 694 | 759 | 885 | 1010 | 1137 |
| | 66 | 320 | 372 | 427 | 487 | 558 | 627 | 694 | 767 | 836 | 972 | 1111 | 1250 |
| | 72 | 336 | 388 | 451 | 534 | 608 | 683 | 759 | 836 | 909 | 1063 | 1211 | 1363 |
| | 78 | 354 | 414 | 494 | 578 | 658 | 740 | 822 | 905 | 985 | 1149 | 1312 | 1476 |
| | 84 | 362 | 445 | 534 | 621 | 709 | 797 | 885 | 972 | 1063 | 1237 | 1412 | 1592 |
| | 90 | 379 | 477 | 571 | 666 | 759 | 854 | 948 | 1043 | 1137 | 1326 | 1514 | 1703 |
| | 96 | 409 | 508 | 608 | 709 | 810 | 909 | 1010 | 1111 | 1211 | 1412 | 1613 | 1814 |
| | 108 | 456 | 571 | 683 | 797 | 909 | 1022 | 1137 | 1250 | 1363 | 1592 | 1814 | 2040 |
| 120 | 508 | 636 | 759 | 885 | 1010 | 1137 | 1265 | 1386 | 1514 | 1765 | 2014 | 2269 | |

 Cord Loop Hardware is recommended on sizes within the shaded area.
 Motorized Lift Systems are not offered within the shaded area.

| LIFT SYSTEM AND DESIGN UPGRADES | | | ADD |
|---|--|---|---------------------------------|
| Cord Lock | Top Down-Bottom Up | | \$85 |
| Cordless Lift & Lock | Bottom Up | | No Charge |
| | Top Down-Bottom Up | | \$108 |
| Cordless Ultra | Bottom Up | | \$108 |
| | Top Down-Bottom Up | | \$215 |
| Cord Loop | Bottom Up | | \$108 |
| | Top Down-Bottom Up | | \$215 |
| DESIGNER UPGRADE OPTIONS (Add to any Lift System Upgrade Above) | | | ADD |
| Metallic Hardware | | | \$30 |
| Fabric Wrapped Hardware | | | \$48 |
| Scotchgard Stain Protection (Not available on Prelude) | | | \$48 |
| MOTORIZATION* | | | MORE INFO |
| 7.4V PowerTouch Rechargeable | | | Pg 62 \$100 |
| 12V Simplicity - Motor and Battery Wand | | | Pg 52 \$300 |
| 7.4V Simplicity Rechargeable Motorization - Motor with Integrated Battery | | | Pg 54 \$300 |
| Plug-In Charger for Li-Ion Battery Pack (used for PowerTouch and Simplicity Rechargeable and is required) | | | Pg 54 \$30 |
| Simplicity 14 Channel White Remote | | | Pg 58 \$50 |
| Simplicity Smart Controller (NEO) | | | Pg 61 \$280 |
| Top Down-Bottom Up Motorization and Solar Charge Option Pricing | | | Pg 15 |
| 7.4V EZ Charge Extension Wand | Wall Mount Receiver Kit 7.4V | \$18 | For More Information Page 59 |
| | Extendable Wand 7.4V | \$32 | |
| 12V Low Voltage Hardwiring (Not available on Prelude) | 9 Channel Wall Mount Hardwired Transformer 12V | \$232 | For More Information Page 60 |
| ADDITIONAL OPTIONS | | MORE INFO | |
| Prints & Custom Graphics | | Add 20% - Includes Anna Cote, Gradients, Spheres, Tuscan Scroll and Custom Graphics | |
| For additional options and surcharges refer to page 15. | | Pg 15 | |

*Motorized Pricing Examples pages 14, 53, 55 and 58

Cellular Shade Collection
PRICING

Premiere 3/4" Karma-Light Room Darkening & Blackout

PRICE GROUP 4
Cord Lock
Cordless Lift & Lock

| | | Width In Inches | | | | | | | | | | | |
|------------------|-----|-----------------|-----|------|------|------|------|------|------|------|------|------|------|
| | | 24 | 30 | 36 | 42 | 48 | 54 | 60 | 66 | 72 | 84 | 96 | 108 |
| Length In Inches | 36 | 309 | 343 | 396 | 437 | 483 | 525 | 568 | 607 | 653 | 749 | 841 | 933 |
| | 42 | 327 | 376 | 422 | 473 | 525 | 570 | 624 | 668 | 720 | 827 | 928 | 1035 |
| | 48 | 347 | 403 | 460 | 511 | 568 | 623 | 674 | 732 | 791 | 920 | 1051 | 1179 |
| | 54 | 373 | 423 | 488 | 547 | 609 | 668 | 741 | 814 | 887 | 1035 | 1179 | 1326 |
| | 60 | 398 | 457 | 525 | 585 | 648 | 741 | 825 | 900 | 983 | 1148 | 1312 | 1475 |
| | 66 | 415 | 483 | 555 | 634 | 723 | 814 | 900 | 995 | 1083 | 1262 | 1442 | 1623 |
| | 72 | 437 | 505 | 585 | 693 | 791 | 887 | 983 | 1083 | 1179 | 1380 | 1571 | 1768 |
| | 78 | 460 | 539 | 642 | 749 | 853 | 959 | 1067 | 1174 | 1279 | 1490 | 1702 | 1915 |
| | 84 | 472 | 578 | 693 | 808 | 920 | 1035 | 1148 | 1262 | 1380 | 1605 | 1832 | 2063 |
| | 90 | 493 | 619 | 741 | 866 | 983 | 1108 | 1231 | 1353 | 1475 | 1720 | 1963 | 2207 |
| | 96 | 530 | 660 | 791 | 920 | 1051 | 1179 | 1312 | 1442 | 1571 | 1832 | 2091 | 2352 |
| | 108 | 592 | 741 | 887 | 1035 | 1179 | 1326 | 1475 | 1623 | 1768 | 2063 | 2352 | 2644 |
| 120 | 660 | 825 | 983 | 1148 | 1312 | 1475 | 1640 | 1797 | 1963 | 2291 | 2610 | 2942 | |

■ Cord Loop Hardware is recommended on sizes within the shaded area.
■ Motorized Lift Systems are not offered within the shaded area.

| LIFT SYSTEM AND DESIGN UPGRADES | | | ADD |
|---|--|-------|---|
| Cord Lock | Top Down-Bottom Up | | \$85 |
| Cordless Lift & Lock | Bottom Up | | No Charge |
| | Top Down-Bottom Up | | \$108 |
| Cordless Ultra | Bottom Up | | \$108 |
| | Top Down-Bottom Up | | \$215 |
| Cord Loop | Bottom Up | | \$108 |
| | Top Down-Bottom Up | | \$215 |
| DESIGNER UPGRADE OPTIONS (Add to any Lift System Upgrade Above) | | | ADD |
| Metallic Hardware | | | \$30 |
| Fabric Wrapped Hardware | | | \$48 |
| Scotchgard Stain Protection (Not available on Prelude) | | | \$48 |
| MOTORIZATION* | | | MORE INFO |
| 7.4V PowerTouch Rechargeable | | | Pg 62 \$100 |
| 12V Simplicity - Motor and Battery Wand | | | Pg 52 \$300 |
| 7.4V Simplicity Rechargeable Motorization - Motor with Integrated Battery | | | Pg 54 \$300 |
| Plug-In Charger for Li-Ion Battery Pack (used for PowerTouch and Simplicity Rechargeable and is required) | | | Pg 56 \$30 |
| Simplicity 14 Channel White Remote | | | Pg 58 \$50 |
| Simplicity Smart Controller (NEO) | | | Pg 61 \$280 |
| Top Down-Bottom Up Motorization and Solar Charge Option Pricing | | | Pg 57 |
| 7.4V EZ Charge Extension Wand | Wall Mount Receiver Kit 7.4V | \$18 | For More Information Page 59 |
| | Extendable Wand 7.4V | \$32 | |
| 12V Low Voltage Hardwiring (Not available on Prelude) | 9 Channel Wall Mount Hardwired Transformer 12V | \$232 | For More Information Page 60 |
| ADDITIONAL OPTIONS | | | MORE INFO |
| Prints & Custom Graphics | | | Add 20% - Includes Anna Cote, Gradients, Spheres, Tuscan Scroll and Custom Graphics |
| For additional options and surcharges refer to page 15. | | | Pg 15 |

*Motorized Pricing Examples pages 14, 53, 55 and 58

Cellular Shade Collection
PRICING

Debut 1/2" Single Cell

PRICE GROUP 5
Cord Lock
Cordless Lift & Lock

| | | Width In Inches | | | | | | | | | | | |
|------------------|-----|-----------------|-----|-----|-----|-----|------|------|------|------|------|------|------|
| | | 24 | 30 | 36 | 42 | 48 | 54 | 60 | 66 | 72 | 84 | 96 | 108 |
| Length In Inches | 36 | 205 | 229 | 263 | 292 | 322 | 351 | 380 | 405 | 434 | 501 | 561 | 623 |
| | 42 | 219 | 251 | 280 | 316 | 351 | 381 | 417 | 447 | 481 | 552 | 619 | 691 |
| | 48 | 232 | 268 | 306 | 342 | 380 | 415 | 451 | 488 | 527 | 614 | 700 | 788 |
| | 54 | 250 | 283 | 325 | 365 | 406 | 447 | 496 | 542 | 592 | 691 | 788 | 886 |
| | 60 | 264 | 305 | 351 | 390 | 434 | 496 | 551 | 601 | 658 | 767 | 874 | 983 |
| | 66 | 277 | 322 | 371 | 423 | 483 | 542 | 601 | 664 | 723 | 842 | 963 | 1082 |
| | 72 | 292 | 336 | 390 | 463 | 527 | 592 | 658 | 723 | 788 | 920 | 1049 | 1179 |
| | 78 | 306 | 359 | 429 | 501 | 569 | 641 | 713 | 782 | 853 | 995 | 1136 | 1278 |
| | 84 | 315 | 386 | 463 | 538 | 614 | 691 | 767 | 842 | 920 | 1071 | 1224 | 1378 |
| | 90 | 329 | 413 | 496 | 578 | 658 | 739 | 821 | 903 | 983 | 1149 | 1310 | 1474 |
| | 96 | 354 | 439 | 527 | 614 | 700 | 788 | 874 | 963 | 1049 | 1224 | 1397 | 1570 |
| 108 | 397 | 496 | 592 | 691 | 788 | 886 | 983 | 1082 | 1179 | 1378 | 1570 | 1766 | |
| 120 | 439 | 551 | 658 | 767 | 874 | 983 | 1095 | 1200 | 1310 | 1528 | 1744 | 1963 | |

| LIFT SYSTEM AND DESIGN UPGRADES | | | ADD |
|---|--|-------|---|
| Cord Lock | Top Down-Bottom Up | | \$85 |
| Cordless Lift & Lock | Bottom Up | | No Charge |
| | Top Down-Bottom Up | | \$108 |
| Cordless Ultra | Bottom Up | | \$108 |
| | Top Down-Bottom Up | | \$215 |
| Cord Loop | Bottom Up | | \$108 |
| | Top Down-Bottom Up | | \$215 |
| DESIGNER UPGRADE OPTIONS (Add to any Lift System Upgrade Above) | | | ADD |
| Metallic Hardware | | | \$30 |
| Fabric Wrapped Hardware | | | \$48 |
| Scotchgard Stain Protection <i>(Not available on Prelude)</i> | | | \$48 |
| MOTORIZATION* | | | MORE INFO |
| 7.4V PowerTouch Rechargeable | | | Pg 62 \$100 |
| 12V Simplicity - Motor and Battery Wand | | | Pg 52 \$300 |
| 7.4V Simplicity Rechargeable Motorization - Motor with Integrated Battery | | | Pg 54 \$300 |
| Plug-In Charger for Li-Ion Battery Pack (used for PowerTouch and Simplicity Rechargeable and is required) | | | Pg 56 \$30 |
| Simplicity 14 Channel White Remote | | | Pg 58 \$50 |
| Simplicity Smart Controller (NEO) | | | Pg 61 \$280 |
| Top Down-Bottom Up Motorization and Solar Charge Option Pricing | | | Pg 57 |
| 7.4V EZ Charge Extension Wand | Wall Mount Receiver Kit 7.4V | \$18 | For More Information Page 59 |
| | Extendable Wand 7.4V | \$32 | |
| 12V Low Voltage Hardwiring <i>(Not available on Prelude)</i> | 9 Channel Wall Mount Hardwired Transformer 12V | \$232 | For More Information Page 60 |
| ADDITIONAL OPTIONS | | | MORE INFO |
| Prints & Custom Graphics | | | Add 20% - Includes Anna Cote, Gradients, Spheres, Tuscan Scroll and Custom Graphics |
| For additional options and surcharges refer to page 15. | | | Pg 15 |

*Motorized Pricing Examples pages 14, 53, 55 and 58

Cellular Shade Collection
PRICING

Debut 3/4" Single Cell
Debut 1/2" Double Cell

PRICE GROUP 6
Cord Lock
Cordless Lift & Lock

| | | Width In Inches | | | | | | | | | | | |
|------------------|-----|-----------------|-----|-----|-----|------|------|------|------|------|------|------|------|
| | | 24 | 30 | 36 | 42 | 48 | 54 | 60 | 66 | 72 | 84 | 96 | 108 |
| Length In Inches | 36 | 226 | 252 | 292 | 321 | 355 | 385 | 418 | 447 | 480 | 551 | 618 | 685 |
| | 42 | 241 | 277 | 310 | 348 | 385 | 420 | 458 | 492 | 528 | 607 | 681 | 761 |
| | 48 | 255 | 296 | 338 | 376 | 418 | 457 | 496 | 538 | 581 | 676 | 770 | 867 |
| | 54 | 276 | 312 | 357 | 401 | 448 | 492 | 547 | 597 | 653 | 761 | 867 | 975 |
| | 60 | 292 | 336 | 385 | 430 | 477 | 547 | 607 | 661 | 723 | 844 | 964 | 1082 |
| | 66 | 305 | 355 | 408 | 465 | 532 | 597 | 661 | 732 | 796 | 926 | 1059 | 1190 |
| | 72 | 321 | 371 | 430 | 509 | 581 | 653 | 723 | 796 | 867 | 1011 | 1154 | 1296 |
| | 78 | 338 | 397 | 472 | 551 | 627 | 706 | 785 | 862 | 940 | 1095 | 1250 | 1405 |
| | 84 | 347 | 426 | 509 | 592 | 676 | 761 | 844 | 926 | 1011 | 1178 | 1345 | 1516 |
| | 90 | 362 | 454 | 547 | 636 | 723 | 814 | 904 | 994 | 1082 | 1264 | 1442 | 1623 |
| | 96 | 389 | 484 | 581 | 676 | 770 | 867 | 964 | 1059 | 1154 | 1345 | 1536 | 1727 |
| | 108 | 435 | 547 | 653 | 761 | 867 | 975 | 1082 | 1190 | 1296 | 1516 | 1727 | 1943 |
| 120 | 484 | 607 | 723 | 844 | 964 | 1082 | 1205 | 1320 | 1442 | 1682 | 1918 | 2161 | |

| LIFT SYSTEM AND DESIGN UPGRADES | | | ADD |
|---|--|-------|---|
| Cord Lock | Top Down-Bottom Up | | \$85 |
| Cordless Lift & Lock | Bottom Up | | No Charge |
| | Top Down-Bottom Up | | \$108 |
| Cordless Ultra | Bottom Up | | \$108 |
| | Top Down-Bottom Up | | \$215 |
| Cord Loop | Bottom Up | | \$108 |
| | Top Down-Bottom Up | | \$215 |
| DESIGNER UPGRADE OPTIONS (Add to any Lift System Upgrade Above) | | | ADD |
| Metallic Hardware | | | \$30 |
| Fabric Wrapped Hardware | | | \$48 |
| Scotchgard Stain Protection (Not available on Prelude) | | | \$48 |
| MOTORIZATION* | | | MORE INFO |
| 7.4V PowerTouch Rechargeable | | | Pg 62 |
| 12V Simplicity - Motor and Battery Wand | | | Pg 52 |
| 7.4V Simplicity Rechargeable Motorization - Motor with Integrated Battery | | | Pg 54 |
| Plug-In Charger for Li-Ion Battery Pack (used for PowerTouch and Simplicity Rechargeable and is required) | | | Pg 56 |
| Simplicity 14 Channel White Remote | | | Pg 58 |
| Simplicity Smart Controller (NEO) | | | Pg 61 |
| Top Down-Bottom Up Motorization and Solar Charge Option Pricing | | | Pg 57 |
| 7.4V EZ Charge Extension Wand | Wall Mount Receiver Kit 7.4V | \$18 | For More Information Page 59 |
| | Extendable Wand 7.4V | \$32 | |
| 12V Low Voltage Hardwiring (Not available on Prelude) | 9 Channel Wall Mount Hardwired Transformer 12V | \$232 | For More Information Page 60 |
| ADDITIONAL OPTIONS | | | MORE INFO |
| Prints & Custom Graphics | | | Add 20% - Includes Anna Cote, Gradients, Spheres, Tuscan Scroll and Custom Graphics |
| For additional options and surcharges refer to page 15. | | | Pg 15 |

*Motorized Pricing Examples pages 14, 53, 55 and 58

Cellular Shade Collection

PRICING



Symphony 3/8" Light Filtering

PRICE GROUP 7

Cord Lock

Cordless Lift & Lock

| | | Width In Inches | | | | | | | | | | | |
|------------------|-----|-----------------|-----|-----|-----|-----|------|------|------|------|------|------|------|
| | | 24 | 30 | 36 | 42 | 48 | 54 | 60 | 66 | 72 | 84 | 96 | 108 |
| Length In Inches | 36 | 196 | 218 | 250 | 277 | 306 | 333 | 360 | 386 | 414 | 476 | 534 | 594 |
| | 42 | 208 | 238 | 267 | 300 | 333 | 362 | 397 | 426 | 457 | 525 | 589 | 658 |
| | 48 | 220 | 255 | 292 | 325 | 360 | 396 | 429 | 464 | 502 | 584 | 667 | 749 |
| | 54 | 238 | 270 | 310 | 347 | 387 | 426 | 472 | 518 | 564 | 658 | 749 | 842 |
| | 60 | 251 | 292 | 333 | 372 | 413 | 472 | 524 | 571 | 626 | 731 | 833 | 937 |
| | 66 | 263 | 306 | 352 | 403 | 460 | 518 | 571 | 632 | 690 | 801 | 916 | 1029 |
| | 72 | 277 | 321 | 372 | 439 | 502 | 564 | 626 | 690 | 749 | 874 | 999 | 1124 |
| | 78 | 292 | 342 | 408 | 476 | 542 | 610 | 678 | 744 | 812 | 946 | 1082 | 1216 |
| | 84 | 299 | 368 | 439 | 511 | 584 | 658 | 731 | 801 | 874 | 1020 | 1163 | 1310 |
| | 90 | 313 | 393 | 472 | 549 | 626 | 703 | 781 | 860 | 937 | 1094 | 1248 | 1403 |
| | 96 | 336 | 418 | 502 | 584 | 667 | 749 | 833 | 916 | 999 | 1163 | 1329 | 1494 |
| | 108 | 376 | 472 | 564 | 658 | 749 | 842 | 937 | 1029 | 1124 | 1310 | 1494 | 1682 |
| 120 | 418 | 524 | 626 | 731 | 833 | 937 | 1041 | 1142 | 1248 | 1456 | 1660 | 1870 | |

 Cord Loop Hardware is recommended on sizes within the shaded area.
 Motorized Lift Systems are not offered within the shaded area.

| FABRIC SURCHARGES | | ADD | |
|---|--|------------------------------|-------|
| Prints and Duotones | | 20% | |
| Flame Resistant 3/8" double cell | | 30% | |
| Flame Resistant 3/4" single cell | | 30% | |
| LIFT SYSTEM AND DESIGN UPGRADES | | ADD | |
| Cord Lock | Top Down-Bottom Up | \$85 | |
| Cordless Lift & Lock | Bottom Up | No Charge | |
| | Top Down-Bottom Up | \$108 | |
| Cordless Ultra | Bottom Up | \$108 | |
| | Top Down-Bottom Up | \$215 | |
| Cord Loop | Bottom Up | \$108 | |
| | Top Down-Bottom Up | \$215 | |
| DESIGNER UPGRADE OPTIONS (Add to any Lift System Upgrade Above) | | ADD | |
| Metallic Hardware | | \$30 | |
| Fabric Wrapped Hardware | | \$48 | |
| Scotchgard Stain Protection (Not available on Prelude) | | \$48 | |
| MOTORIZATION* | | MORE INFO | ADD |
| 7.4V PowerTouch Rechargeable | | Pg 62 | \$100 |
| 12V Simplicity - Motor and Battery Wand | | Pg 52 | \$300 |
| 7.4V Simplicity Rechargeable Motorization - Motor with Integrated Battery | | Pg 54 | \$300 |
| Plug-In Charger for Li-Ion Battery Pack (used for PowerTouch and Simplicity Rechargeable and is required) | | Pg 56 | \$30 |
| Simplicity 14 Channel White Remote | | Pg 58 | \$50 |
| Simplicity Smart Controller (NEO) | | Pg 61 | \$280 |
| Top Down-Bottom Up Motorization and Solar Charge Option Pricing | | Pg 57 | |
| 7.4V EZ Charge Extension Wand | Wall Mount Receiver Kit 7.4V | | \$18 |
| | Extendable Wand 7.4V | | \$32 |
| 12V Low Voltage Hardwiring (Not available on Prelude) | 9 Channel Wall Mount Hardwired Transformer 12V | | \$232 |
| | | For More Information Page 59 | |
| | | For More Information Page 60 | |
| ADDITIONAL OPTIONS | | MORE INFO | |
| For additional options and surcharges refer to page 15. | | Pg 15 | |

*Motorized Pricing Examples pages 14, 53, 55 and 58

Cellular Shade Collection

PRICING

Symphony 3/8" Blackout

PRICE GROUP 8

Cord Lock

Cordless Lift & Lock

| | Width In Inches | | | | | | | | | | | | |
|-----|-----------------|-----|-----|-----|------|------|------|------|------|------|------|------|------|
| | 24 | 30 | 36 | 42 | 48 | 54 | 60 | 66 | 72 | 84 | 96 | 108 | 120 |
| 36 | 254 | 281 | 325 | 359 | 399 | 432 | 471 | 502 | 539 | 618 | 693 | 770 | 852 |
| 42 | 271 | 310 | 347 | 389 | 432 | 472 | 514 | 552 | 595 | 681 | 766 | 854 | 948 |
| 48 | 285 | 331 | 377 | 423 | 471 | 512 | 557 | 605 | 653 | 760 | 867 | 975 | 1082 |
| 54 | 309 | 351 | 403 | 451 | 505 | 552 | 613 | 672 | 732 | 854 | 975 | 1095 | 1217 |
| 60 | 327 | 376 | 432 | 483 | 538 | 613 | 680 | 744 | 814 | 948 | 1082 | 1217 | 1354 |
| 66 | 342 | 399 | 457 | 524 | 597 | 672 | 744 | 821 | 895 | 1042 | 1190 | 1338 | 1487 |
| 72 | 359 | 415 | 483 | 571 | 653 | 732 | 814 | 895 | 975 | 1138 | 1296 | 1460 | 1623 |
| 78 | 377 | 445 | 530 | 618 | 706 | 793 | 881 | 967 | 1055 | 1231 | 1405 | 1581 | 1757 |
| 84 | 388 | 476 | 571 | 664 | 760 | 854 | 948 | 1042 | 1138 | 1326 | 1515 | 1703 | 1891 |
| 90 | 406 | 510 | 613 | 714 | 814 | 915 | 1017 | 1116 | 1217 | 1421 | 1623 | 1824 | 2027 |
| 96 | 437 | 543 | 653 | 760 | 867 | 975 | 1082 | 1190 | 1296 | 1515 | 1728 | 1943 | 2161 |
| 108 | 489 | 613 | 732 | 854 | 975 | 1095 | 1217 | 1338 | 1460 | 1703 | 1943 | 2186 | 2430 |
| 120 | 543 | 680 | 814 | 948 | 1082 | 1217 | 1354 | 1485 | 1623 | 1891 | 2158 | 2430 | 2700 |

 Cord Loop Hardware is recommended on sizes within the shaded area.
Motorized Lift Systems are not offered within the shaded area.

| LIFT SYSTEM AND DESIGN UPGRADES | | | ADD |
|---|---|-------|---------------------------------|
| Cord Lock | Top Down-Bottom Up | | \$85 |
| Cordless Lift & Lock | Bottom Up | | No Charge |
| | Top Down-Bottom Up | | \$108 |
| Cordless Ultra | Bottom Up | | NA |
| | Top Down-Bottom Up | | NA |
| Cord Loop | Bottom Up | | \$108 |
| | Top Down-Bottom Up | | \$215 |
| DESIGNER UPGRADE OPTIONS (Add to any Lift System Upgrade Above) | | | ADD |
| Metallic Hardware | | | \$30 |
| Fabric Wrapped Hardware | | | \$48 |
| Scotchgard Stain Protection (Not available on Prelude) | | | \$48 |
| MOTORIZATION* | | | MORE INFO |
| 7.4V PowerTouch Rechargeable | | | Pg 62 |
| 12V Simplicity - Motor and Battery Wand | | | Pg 52 |
| 7.4V Simplicity Rechargeable Motorization - Motor with Integrated Battery | | | Pg 54 |
| Plug-In Charger for Li-Ion Battery Pack (used for PowerTouch and Simplicity Rechargeable and is required) | | | Pg 56 |
| Simplicity 14 Channel White Remote | | | Pg 58 |
| Simplicity Smart Controller (NEO) | | | Pg 61 |
| Top Down-Bottom Up Motorization and Solar Charge Option Pricing | | | Pg 57 |
| 7.4V EZ Charge Extension Wand | Wall Mount Receiver Kit 7.4V | \$18 | For More Information Page 59 |
| | Extendable Wand 7.4V | \$32 | |
| 12V Low Voltage Hardwiring (Not available on Prelude) | 9 Channel Wall Mount Hardwired Transformer 12V | \$232 | For More Information Page 60 |
| ADDITIONAL OPTIONS | | | MORE INFO |
| For additional options and surcharges refer to page 83. | | | Pg 83 |

*Motorized Pricing Examples pages 14, 53, 55 and 58

**Cellular Shade Collection
PRICING**

This fabric is best for Room Darkening SlumberShades.

**SlumberShade Fabric
Premiere 3/4" Blackout**

**PRICE GROUP 9
SlumberShade Fabric**

Price grid is for shades only. SlumberShade Tracks are a separate charge - See below.

| | | Width In Inches | | | | | | | | | | | |
|------------------|-----|-----------------|-----|------|------|------|------|------|------|------|------|------|------|
| | | 24 | 30 | 36 | 42 | 48 | 54 | 60 | 66 | 72 | 84 | 96 | 108 |
| Length In Inches | 36 | 309 | 343 | 396 | 437 | 483 | 525 | 568 | 607 | 653 | 749 | 841 | 933 |
| | 42 | 327 | 376 | 422 | 473 | 525 | 570 | 624 | 668 | 720 | 827 | 928 | 1035 |
| | 48 | 347 | 403 | 460 | 511 | 568 | 623 | 674 | 732 | 791 | 920 | 1051 | 1179 |
| | 54 | 373 | 423 | 488 | 547 | 609 | 668 | 741 | 814 | 887 | 1035 | 1179 | 1326 |
| | 60 | 398 | 457 | 525 | 585 | 648 | 741 | 825 | 900 | 983 | 1148 | 1312 | 1475 |
| | 66 | 415 | 483 | 555 | 634 | 723 | 814 | 900 | 995 | 1083 | 1262 | 1442 | 1623 |
| | 72 | 437 | 505 | 585 | 693 | 791 | 887 | 983 | 1083 | 1179 | 1380 | 1571 | 1768 |
| | 78 | 460 | 539 | 642 | 749 | 853 | 959 | 1067 | 1174 | 1279 | 1490 | 1702 | 1915 |
| | 84 | 472 | 578 | 693 | 808 | 920 | 1035 | 1148 | 1262 | 1380 | 1605 | 1832 | 2063 |
| | 90 | 493 | 619 | 741 | 866 | 983 | 1108 | 1231 | 1353 | 1475 | 1720 | 1963 | 2207 |
| | 96 | 530 | 660 | 791 | 920 | 1051 | 1179 | 1312 | 1442 | 1571 | 1832 | 2091 | 2352 |
| | 108 | 592 | 741 | 887 | 1035 | 1179 | 1326 | 1475 | 1623 | 1768 | 2063 | 2352 | 2644 |
| 120 | 660 | 825 | 983 | 1148 | 1312 | 1475 | 1640 | 1797 | 1963 | 2291 | 2610 | 2942 | |

 Cord Loop Hardware is recommended on sizes within the shaded area. Motorized Lift Systems are not offered within the shaded area.

| LIFT SYSTEM AND DESIGN UPGRADES | | | ADD |
|---|--|-------|---------------------------------|
| Cord Lock | Top Down-Bottom Up | | \$85 |
| Cordless Lift & Lock | Bottom Up | | No Charge |
| | Top Down-Bottom Up | | \$108 |
| Cordless Ultra | Bottom Up | | \$108 |
| | Top Down-Bottom Up | | \$215 |
| Cord Loop | Bottom Up | | \$108 |
| | Top Down-Bottom Up | | \$215 |
| DESIGNER UPGRADE OPTIONS (Add to any Lift System Upgrade Above) | | | ADD |
| Metallic Hardware | | | \$30 |
| Fabric Wrapped Hardware | | | \$48 |
| Scotchgard Stain Protection (Not available on Prelude) | | | \$48 |
| MOTORIZATION* | | | MORE INFO |
| 7.4V PowerTouch Rechargeable | | | Pg 62 |
| 12V Simplicity - Motor and Battery Wand | | | Pg 52 |
| 7.4V Simplicity Rechargeable Motorization - Motor with Integrated Battery | | | Pg 54 |
| Plug-In Charger for Li-Ion Battery Pack (used for PowerTouch and Simplicity Rechargeable and is required) | | | Pg 56 |
| Simplicity 14 Channel White Remote | | | Pg 58 |
| Simplicity Smart Controller (NEO) | | | Pg 61 |
| Top Down-Bottom Up Motorization and Solar Charge Option Pricing | | | Pg 57 |
| 7.4V EZ Charge Extension Wand | Wall Mount Receiver Kit 7.4V | \$18 | For More Information Page 59 |
| | Extendable Wand 7.4V | \$32 | |
| 12V Low Voltage Hardwiring (Not available on Prelude) | 9 Channel Wall Mount Hardwired Transformer 12V | \$232 | For More Information Page 60 |
| ADDITIONAL OPTIONS | | | ADD |
| Slumbershade Light Blocking Sidetrack System See page 66 for more information. | | | \$174 |

*Motorized Pricing Examples pages 14, 53, 55 and 58

Ovation Cellular Slider Shade

PRICING

LIGHT FILTERING FABRICS

Debut 1/2" Premiere 3/4"
 Debut 1/2" Double Cell Symphony 3/8"
 Debut 3/4" Virtuoso 1/2"

PRICE GROUP 10

Ovation Cellular Slider

| | | Width In Inches | | | | | | | | | | | | | | | | | |
|------------------|------|-----------------|------|------|------|------|------|------|------|------|------|------|------|------|------|------|------|------|------|
| | | 24 | 30 | 36 | 42 | 48 | 54 | 60 | 66 | 72 | 78 | 84 | 96 | 108 | 120 | 132 | 144 | 156 | 168 |
| Length In Inches | 36 | 690 | 748 | 814 | 873 | 924 | 987 | 1049 | 1103 | 1163 | 1231 | 1284 | 1388 | 1493 | 1606 | 1715 | 1827 | 1941 | 2053 |
| | 42 | 733 | 804 | 874 | 946 | 1003 | 1071 | 1144 | 1206 | 1279 | 1344 | 1403 | 1525 | 1643 | 1778 | 1906 | 2036 | 2167 | 2299 |
| | 48 | 781 | 852 | 941 | 1016 | 1082 | 1154 | 1234 | 1312 | 1386 | 1451 | 1528 | 1672 | 1797 | 1943 | 2087 | 2230 | 2372 | 2518 |
| | 54 | 824 | 912 | 999 | 1083 | 1155 | 1237 | 1318 | 1409 | 1493 | 1571 | 1654 | 1808 | 1954 | 2111 | 2271 | 2427 | 2590 | 2747 |
| | 60 | 870 | 964 | 1057 | 1151 | 1234 | 1323 | 1415 | 1510 | 1598 | 1686 | 1775 | 1944 | 2107 | 2277 | 2455 | 2627 | 2800 | 2979 |
| | 66 | 920 | 1020 | 1122 | 1219 | 1312 | 1409 | 1502 | 1615 | 1706 | 1808 | 1889 | 2087 | 2259 | 2447 | 2628 | 2815 | 3000 | 3186 |
| | 72 | 970 | 1074 | 1183 | 1293 | 1397 | 1494 | 1597 | 1714 | 1819 | 1924 | 2016 | 2233 | 2410 | 2619 | 2826 | 3038 | 3246 | 3454 |
| | 78 | 1020 | 1133 | 1249 | 1368 | 1476 | 1585 | 1692 | 1820 | 1927 | 2037 | 2138 | 2364 | 2563 | 2785 | 3003 | 3225 | 3447 | 3668 |
| | 84 | 1071 | 1189 | 1310 | 1443 | 1559 | 1672 | 1787 | 1922 | 2037 | 2158 | 2263 | 2505 | 2716 | 2948 | 3186 | 3420 | 3651 | 3884 |
| | 90 | 1116 | 1243 | 1380 | 1517 | 1631 | 1760 | 1885 | 2028 | 2150 | 2274 | 2393 | 2648 | 2866 | 3124 | 3383 | 3642 | 3901 | 4161 |
| | 96 | 1162 | 1300 | 1444 | 1588 | 1712 | 1840 | 1986 | 2131 | 2263 | 2396 | 2515 | 2790 | 3024 | 3288 | 3555 | 3822 | 4090 | 4353 |
| | 108 | 1208 | 1350 | 1506 | 1660 | 1789 | 1927 | 2081 | 2228 | 2372 | 2515 | 2640 | 2932 | 3179 | 3454 | 3726 | 4001 | 4272 | 4545 |
| 114 | 1270 | 1417 | 1585 | 1743 | 1879 | 2023 | 2197 | 2348 | 2497 | 2652 | 2782 | 3092 | 3353 | 3635 | 3902 | 4176 | 4446 | 4720 | |
| 120 | 1333 | 1489 | 1668 | 1827 | 1971 | 2121 | 2305 | 2462 | 2625 | 2789 | 2924 | 3250 | 3526 | 3816 | 4097 | 4377 | 4660 | 4940 | |

PRODUCT INFORMATION

See Page 64 for detailed information.

DESIGN UPGRADES

| | |
|---------------------|---|
| Left or Right Stack | Included, specify when ordering |
| Center Stack | Add \$108 |
| Split Stack* | Price by dividing the full width measurement in half. Price as two separate units and add together. |
| Dual Panel** | Price as two separate units and add together. |

FABRIC SURCHARGES

| | ADD |
|----------------------------------|---------|
| Prints and Duotones | Add 20% |
| Flame Resistant 3/8" Double Cell | Add 30% |
| Flame Resistant 3/4" Single Cell | Add 30% |

* Split stack sliders are available in widths up to 240". If the width exceeds 120", it will be fabricated as two separate sliders. The supplied valance will create the appearance of a single slider.

** A Dual Panel Stack Slider has a center opening design with a different fabric on each side, each of which can span the full width of the window. Both panels will be of equal width unless otherwise specified.

Ovation Cellular Slider Shade

PRICING

ROOM DARKENING & BLACKOUT FABRICS

Premiere 3/4" Blackout

PRICE GROUP 11

Ovation Cellular Slider

| | | Width In Inches | | | | | | | | | | | | | | | | | |
|------------------|------|-----------------|------|------|------|------|------|------|------|------|------|------|------|------|------|------|------|------|------|
| | | 24 | 30 | 36 | 42 | 48 | 54 | 60 | 66 | 72 | 78 | 84 | 96 | 108 | 120 | 132 | 144 | 156 | 168 |
| Length In Inches | 36 | 898 | 971 | 1057 | 1134 | 1201 | 1283 | 1364 | 1434 | 1515 | 1600 | 1669 | 1804 | 1941 | 2087 | 2229 | 2376 | 2525 | 2668 |
| | 42 | 952 | 1046 | 1138 | 1230 | 1304 | 1391 | 1487 | 1568 | 1663 | 1748 | 1824 | 1983 | 2135 | 2310 | 2478 | 2646 | 2818 | 2989 |
| | 48 | 1017 | 1108 | 1224 | 1319 | 1409 | 1500 | 1605 | 1706 | 1802 | 1886 | 1987 | 2173 | 2337 | 2526 | 2713 | 2899 | 3083 | 3273 |
| | 54 | 1071 | 1185 | 1296 | 1409 | 1501 | 1611 | 1712 | 1832 | 1941 | 2042 | 2150 | 2351 | 2539 | 2743 | 2952 | 3156 | 3367 | 3571 |
| | 60 | 1130 | 1253 | 1374 | 1494 | 1605 | 1720 | 1837 | 1963 | 2078 | 2191 | 2307 | 2527 | 2739 | 2961 | 3191 | 3414 | 3639 | 3874 |
| | 66 | 1196 | 1326 | 1459 | 1586 | 1706 | 1830 | 1954 | 2099 | 2218 | 2351 | 2455 | 2713 | 2936 | 3181 | 3417 | 3659 | 3900 | 4141 |
| | 72 | 1262 | 1397 | 1538 | 1683 | 1819 | 1943 | 2077 | 2228 | 2363 | 2501 | 2622 | 2901 | 3133 | 3405 | 3673 | 3949 | 4220 | 4488 |
| | 78 | 1326 | 1473 | 1623 | 1778 | 1919 | 2061 | 2200 | 2366 | 2504 | 2650 | 2779 | 3074 | 3330 | 3619 | 3906 | 4191 | 4483 | 4768 |
| | 84 | 1391 | 1546 | 1703 | 1877 | 2027 | 2173 | 2324 | 2497 | 2650 | 2804 | 2942 | 3257 | 3531 | 3833 | 4141 | 4446 | 4748 | 5050 |
| | 90 | 1451 | 1617 | 1794 | 1971 | 2122 | 2287 | 2452 | 2635 | 2794 | 2954 | 3110 | 3442 | 3727 | 4061 | 4398 | 4733 | 5072 | 5407 |
| | 96 | 1512 | 1689 | 1878 | 2063 | 2225 | 2393 | 2581 | 2770 | 2942 | 3115 | 3270 | 3627 | 3931 | 4275 | 4621 | 4968 | 5319 | 5660 |
| | 108 | 1571 | 1753 | 1958 | 2158 | 2325 | 2504 | 2705 | 2896 | 3082 | 3270 | 3432 | 3814 | 4132 | 4490 | 4844 | 5199 | 5554 | 5906 |
| 114 | 1652 | 1841 | 2061 | 2265 | 2444 | 2629 | 2856 | 3050 | 3246 | 3446 | 3617 | 4019 | 4361 | 4726 | 5074 | 5428 | 5779 | 6135 | |
| 120 | 1732 | 1935 | 2167 | 2376 | 2563 | 2757 | 2998 | 3200 | 3412 | 3626 | 3801 | 4225 | 4583 | 4959 | 5327 | 5691 | 6057 | 6422 | |

PRODUCT INFORMATION

See Page 64 for detailed information.

DESIGN UPGRADES

| | |
|---------------------|---|
| Left or Right Stack | Included, specify when ordering |
| Center Stack | Add \$108 |
| Split Stack* | Price by dividing the full width measurement in half. Price as two separate units and add together. |
| Dual Panel** | Price as two separate units and add together. |

FABRIC SURCHARGES

| | ADD |
|----------------------------------|---------|
| Prints and Duotones | Add 20% |
| Flame Resistant 3/8" Double Cell | Add 30% |
| Flame Resistant 3/4" Single Cell | Add 30% |

* Split stack sliders are available in widths up to 240". If the width exceeds 120", it will be fabricated as two separate sliders. The supplied valance will create the appearance of a single slider.

** A Dual Panel Stack Slider has a center opening design with a different fabric on each side, each of which can span the full width of the window. Both panels will be of equal width unless otherwise specified.

Speciality Shaped Shades
PRICING

LIGHT FILTERING FABRICS

Debut 1/2" Single Cell
Debut 1/2" Double Cell
Debut 3/4" Single Cell
Premiere 1/2"

Premiere 3/4"
Symphony 3/8" Double Cell

PRICE GROUP 12
Starburst Arches
Quarter Rounds

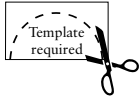

For widths wider than 58"

| Length In Inches | Width In Inches | | | | | | | | | | | | |
|----------------------------|-----------------|-----|-----|-----|------|------|------|------|------|------|------|------|------|
| | 24 | 30 | 36 | 42 | 48 | 54 | 60 | 66 | 72 | 78 | 84 | 90 | 96 |
| Non-Movable Starburst | 373 | 423 | 481 | 547 | 655 | 749 | 845 | 952 | 1074 | 1200 | 1333 | 1477 | 1643 |
| Movable Starburst | 526 | 595 | 678 | 765 | 915 | 1024 | 1154 | 1289 | 1439 | | | | |
| Non-Movable Quarter Rounds | 481 | 547 | 623 | 710 | 808 | 917 | | | | | | | |
| Movable Quarter Rounds | 655 | 741 | 842 | 949 | 1074 | | | | | | | | |

Product Information: All fabrics are not available in all widths, lengths and hardware options. Refer to Size Specifications on page 8 and 9 for availability. See pages 68 and 71-72 for detailed information. Templates required on non-perfect non-movable Starburst Arches and Quarter Rounds. Movable Starburst Arch shades are for inside and shallow mount applications only.

| FABRIC SURCHARGES | | ADD |
|--|---|------------|
| Scotchgard Stain Protector (Not available on Prelude) | | \$48 |
| Debut 1/2" Single Cell Print Fabric | Includes: Homespun, Country Woven, Florance, Strata, Angel Hair, Blossom, Terrazzo and Strie | 20% |
| Debut 1/2" Double Cell Print Fabric Debut 3/4" Single Cell Print Fabric | Includes: Homespun, Country Woven, Florance, Strata and Angel Hair | 20% |
| Premiere Fabric | Includes: Homespun, Country Woven, Florance, Spheres, Strata, Tuscan Scroll, Angel Hair, Blossom, and Gradients | 20% |
| Symphony Fabric | Symphony Prints and Duotones | 20% |
| | Symphony Double Cell Flame Resistant | 30% |
| PRICING INFORMATION | | |
| Starburst Arches | Price according to the largest radius measurement. If the height is greater than the width, take height X 2 and use that number to determine pricing. Metallic rails available. | |
| Quarter Rounds | Price according to the largest radius measurement. | |
| HARDWARE UPGRADE SURCHARGES* AND ACCESSORIES | | ADD |
| 5-10 Foot Expandable Pole - Black | | \$54 |

Speciality Shaped Shades PRICING

ROOM DARKENING & BLACKOUT FABRICS

Premiere 1/2"
Premiere 3/4"

Symphony 3/8" Double Cell

PRICE GROUP 13
Starburst Arches
Quarter Round

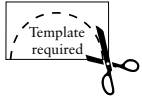

For widths wider than 58"

| Length In Inches | Width In Inches | | | | | | | | | | | | |
|----------------------------|-----------------|-----|------|------|------|------|------|------|------|------|------|------|------|
| | 24 | 30 | 36 | 42 | 48 | 54 | 60 | 66 | 72 | 78 | 84 | 90 | 96 |
| Non-Movable Starburst | 484 | 551 | 624 | 710 | 850 | 975 | 1097 | 1238 | 1397 | 1560 | 1732 | 1922 | 2135 |
| Movable Starburst | 684 | 773 | 881 | 994 | 1189 | 1332 | 1498 | 1675 | 1870 | | | | |
| Non-Movable Quarter Rounds | 624 | 710 | 810 | 922 | 1049 | 1191 | | | | | | | |
| Movable Quarter Rounds | 850 | 965 | 1095 | 1234 | 1397 | | | | | | | | |

Product Information: All fabrics are not available in all widths, lengths and hardware options. Refer to Size Specifications on page 8 and 9 for availability. See pages 68 and 71-72 for detailed information. Templates required on non-perfect non-movable Starburst Arches and Quarter Rounds. Movable Starburst Arch shades are for inside and shallow mount applications only.

| FABRIC SURCHARGES | | ADD |
|---|---|------|
| Scotchgard Stain Protector (Not available on Prelude) | | \$48 |
| Premiere Fabric Prints | Includes: Honespun, Country Woven, Florance, Spheres, Strata, Tuscan Scroll, Angel Hair, Blossom, and Gradients | 20% |
| PRICING INFORMATION | | |
| Starburst Arches | Price according to the largest radius measurement. If the height is greater than the width, take height X 2 and use that number to determine pricing. Metallic rails available. | |
| Quarter Rounds | Price according to the largest radius measurement. | |
| HARDWARE UPGRADE SURCHARGES* AND ACCESSORIES | | ADD |
| 5-10 Foot Expandable Pole - Black | | \$54 |

Please note: On the Stationary Starburst Arches when the fabric wrapped hardware is selected, the fabric wrap will be spliced in the center of the base rail.

Speciality Shaped Shades PRICING

LIGHT FILTERING

Debut 1/2" Single Cell
Debut 1/2" Double Cell
Debut 3/4" Single Cell
Premiere 1/2"

Premiere 3/4"
Symphony 3/8" Double Cell

PRICE GROUP 14 Sunset Movable Arches

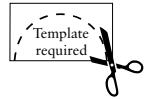

For widths wider than 58"

| | | Width In Inches | | | | | | | | | | |
|------------------|------------|-----------------|-----|-----|------|------|------|------|------|------|------|------|
| | | 24 | 30 | 36 | 42 | 48 | 54 | 60 | 66 | 72 | 78 | 84 |
| Length In Inches | Half Round | 482 | 536 | 568 | 639 | 680 | 763 | 811 | 891 | 975 | 1053 | 1159 |
| | 36 | 623 | 681 | 716 | 765 | 798 | 856 | 883 | 931 | 975 | 1019 | 1055 |
| | 42 | 658 | 724 | 755 | 829 | 860 | 925 | 953 | 1007 | 1055 | 1110 | 1159 |
| | 48 | 697 | 765 | 808 | 881 | 914 | 967 | 1027 | 1082 | 1139 | 1197 | 1262 |
| | 60 | 761 | 856 | 899 | 994 | 1036 | 1125 | 1172 | 1242 | 1308 | | |
| | 72 | 837 | 941 | 996 | 1104 | 1159 | 1264 | 1326 | 1400 | | | |

Product Information: All fabrics are not available in all widths, lengths and hardware options. Refer to Size Specifications on page 9 for availability. See pages 69-70 for detailed information. Templates required on non-perfect Sunset Arches.

| FABRIC SURCHARGES | | ADD |
|--|---|------|
| Scotchgard Stain Protector (Not available on Prelude) | | \$48 |
| Debut 1/2" Single Cell Print Fabric | Includes: Homespun, Country Woven, Florance, Strata, Angel Hair, Blossom, Terrazzo and Strie | 20% |
| Debut 1/2" Double Cell Print Fabric Debut 3/4" Single Cell Print Fabric | Includes: Homespun, Country Woven, Florance, Strata and Angel Hair | 20% |
| Premiere Fabric | Includes: Homespun, Country Woven, Florance, Spheres, Strata, Tuscan Scroll, Angel Hair, Blossom, and Gradients | 20% |
| Symphony Fabric | Symphony Prints and Duotones | 20% |
| | Symphony Double Cell Flame Resistant | 30% |
| HARDWARE UPGRADE SURCHARGES AND ACCESSORIES | | ADD |
| 3 Foot Expandable Pole - Silver | | \$30 |
| 5-10 Foot Expandable Pole - Black | | \$54 |

Speciality Shaped Shades PRICING

ROOM DARKENING & BLACKOUT FABRICS

Premiere 1/2"
 Premiere 3/4"

PRICE GROUP 15 Sunset Movable Arches

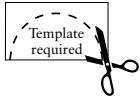

For widths wider than 58"

| | | Width In Inches | | | | | | |
|------------------|------------|-----------------|------|------|------|------|------|------|
| | | 24 | 30 | 36 | 42 | 48 | 54 | 60 |
| Length In Inches | Half Round | 626 | 697 | 739 | 829 | 883 | 992 | 1054 |
| | 36 | 810 | 886 | 931 | 994 | 1038 | 1113 | 1148 |
| | 42 | 854 | 944 | 981 | 1079 | 1116 | 1203 | 1242 |
| | 48 | 904 | 994 | 1049 | 1146 | 1187 | 1258 | 1335 |
| | 60 | 990 | 1113 | 1168 | 1291 | 1346 | 1463 | 1522 |

Product Information: All fabrics are not available in all widths, lengths and hardware options. Refer to Size Specifications on page 9 for availability. See pages 69-70 for detailed information. Templates required on non-perfect Sunset Arches.

| FABRIC SURCHARGES | | ADD |
|---|---|------|
| Scotchgard Stain Protector (Not available on Prelude) | | \$48 |
| Premiere Fabric Prints | Includes: Homespun, Country Woven, Florance, Spheres, Strata, Tuscan Scroll, Angel Hair, Blossom, and Gradients | 20% |
| HARDWARE UPGRADE SURCHARGES AND ACCESSORIES | | ADD |
| 3 Foot Expandable Pole - Silver | | \$30 |
| 5-10 Foot Expandable Pole - Black | | \$54 |

Speciality Shaped Shades
PRICING

LIGHT FILTERING

Debut 1/2" Single Cell
Debut 1/2" Double Cell
Debut 3/4" Single Cell

Premiere 1/2"
Premiere 3/4"
Symphony 3/8" Double Cell

PRICE GROUP 16
Trapezoids and Octagons

| | | Width In Inches | | | | | | |
|------------------|----|-----------------|-----|-----|------|------|------|------|
| | | 24 | 30 | 36 | 42 | 48 | 54 | 60 |
| Length In Inches | 36 | 664 | 703 | 752 | 806 | 852 | 896 | 941 |
| | 42 | 690 | 735 | 788 | 845 | 896 | 946 | 1001 |
| | 48 | 709 | 763 | 827 | 886 | 941 | 998 | 1058 |
| | 54 | 733 | 791 | 860 | 922 | 986 | 1051 | 1112 |
| | 60 | 758 | 823 | 895 | 963 | 1028 | 1106 | 1172 |
| | 66 | 782 | 852 | 931 | 1003 | 1079 | 1155 | 1225 |
| | 72 | 806 | 877 | 963 | 1046 | 1125 | 1206 | 1289 |

All fabrics are not available in all widths, lengths and applications. Refer to Size Specifications on page 9 for availability.
Product Information: See pages 73-74 for detailed information. Width, length and one side are required measurements for Octagon Shades. **Trapezoid orders must be emailed in with a diagram that includes the measurements for 4 sides.** No templates are required for Trapezoid Shades. * Virtuoso fabrics are available as Octagons only. Max width of trapezoid is 60", this refers to full width of top rail.

| FABRIC SURCHARGES | | ADD |
|--|---|------------|
| Scotchgard Stain Protector (Not available on Prelude) | | \$48 |
| Debut 1/2" Single Cell Print Fabric | Includes: Homespun, Country Woven, Florance, Strata, Angel Hair, Blossom, Terrazzo and Strie | 20% |
| Debut 1/2" Double Cell Print Fabric Debut 3/4" Single Cell Print Fabric | Includes: Homespun, Country Woven, Florance, Strata and Angel Hair | 20% |
| Premiere Fabric Prints | Includes: Homespun, Country Woven, Florance, Spheres, Strata, Tuscan Scroll, Angel Hair, Blossom, and Gradients | 20% |
| Symphony Fabric | Symphony Prints and Duotones | 20% |
| | Symphony Double Cell Flame Resistant | 30% |

Speciality Shaped Shades

PRICING

ROOM DARKENING & BLACKOUT FABRICS

Premiere 1/2"

Premiere 3/4"

Symphony 3/8"

PRICE GROUP 17

Trapezoids and Octagons

| | | Width In Inches | | | | | | |
|------------------|----|-----------------|------|------|------|------|------|------|
| | | 24 | 30 | 36 | 42 | 48 | 54 | 60 |
| Length In Inches | 36 | 865 | 915 | 978 | 1047 | 1108 | 1163 | 1224 |
| | 42 | 895 | 953 | 1023 | 1097 | 1163 | 1231 | 1302 |
| | 48 | 921 | 992 | 1074 | 1152 | 1224 | 1296 | 1375 |
| | 54 | 952 | 1027 | 1116 | 1199 | 1281 | 1365 | 1444 |
| | 60 | 983 | 1070 | 1162 | 1251 | 1338 | 1439 | 1522 |
| | 66 | 1017 | 1108 | 1212 | 1304 | 1403 | 1501 | 1591 |
| | 72 | 1047 | 1141 | 1251 | 1359 | 1463 | 1568 | 1675 |

All fabrics are not available in all widths, lengths and applications. Refer to Size Specifications on page 9 for availability.

Product Information: See page 73-74 for detailed information. Templates required on all Octagon orders. Width, length and one side are required measurements for Octagon Shades. **Trapezoid orders must be faxed in with a diagram that includes the measurements for 4 sides.** No templates are required for Trapezoid Shades.

| FABRIC SURCHARGES | | ADD |
|---|---|------|
| Scotchgard Stain Protector (Not available on Prelude) | | \$48 |
| Premiere Fabric Prints | Includes: Homespun, Country Woven, Florance, Spheres, Strata, Tuscan Scroll, Angel Hair, Blossom, and Gradients | 20% |

Comfortex Skylight and Greenhouse Shades

PRICING

LIGHT FILTERING FABRICS

Debut 1/2" Single Cell

Debut 3/4" Single Cell

Premiere 3/4"

Symphony 3/8" Double Cell

PRICE GROUP 18

Soprano Skylights

| | | Width In Inches | | | | | |
|------------------|------|-----------------|------|------|------|------|------|
| | | 26 | 30 | 34 | 38 | 42 | 48 |
| Length In Inches | 30 | 741 | 791 | 842 | 890 | 940 | 995 |
| | 36 | 801 | 860 | 914 | 967 | 1023 | 1080 |
| | 42 | 862 | 926 | 986 | 1046 | 1109 | 1172 |
| | 48 | 926 | 995 | 1061 | 1122 | 1189 | 1263 |
| | 54 | 986 | 1066 | 1133 | 1200 | 1268 | 1348 |
| | 60 | 1051 | 1133 | 1205 | 1280 | 1351 | 1437 |
| | 72 | 1176 | 1262 | 1348 | 1435 | 1521 | 1621 |
| | 84 | 1301 | 1398 | 1501 | 1594 | 1686 | 1802 |
| | 96 | 1432 | 1535 | 1644 | 1748 | 1858 | 1986 |
| | 108 | 1556 | 1673 | 1786 | 1902 | 2019 | 2158 |
| | 120 | 1686 | 1806 | 1938 | 2063 | 2188 | 2338 |
| | 132 | 1809 | 1944 | 2082 | 2218 | 2354 | 2514 |
| | 144 | 1925 | 2083 | 2229 | 2378 | 2521 | 2699 |
| | 156 | 2049 | 2220 | 2378 | 2531 | | |
| 168 | 2170 | 2359 | 2523 | 2686 | | | |
| 180 | 2288 | 2502 | 2667 | 2842 | | | |

ROOM DARKENING FABRICS

Premiere 3/4"

PRICE GROUP 19

Soprano Skylights

| | | Width In Inches | | | | | |
|------------------|------|-----------------|------|------|------|------|------|
| | | 26 | 30 | 34 | 38 | 42 | 48 |
| Length In Inches | 30 | 965 | 1027 | 1095 | 1157 | 1219 | 1292 |
| | 36 | 1042 | 1116 | 1187 | 1258 | 1330 | 1404 |
| | 42 | 1119 | 1204 | 1281 | 1359 | 1442 | 1522 |
| | 48 | 1204 | 1292 | 1380 | 1459 | 1546 | 1642 |
| | 54 | 1281 | 1386 | 1473 | 1560 | 1651 | 1752 |
| | 60 | 1365 | 1473 | 1567 | 1664 | 1757 | 1867 |
| | 72 | 1528 | 1640 | 1752 | 1865 | 1977 | 2107 |
| | 84 | 1690 | 1819 | 1953 | 2070 | 2191 | 2341 |
| | 96 | 1860 | 1994 | 2138 | 2274 | 2416 | 2580 |
| | 108 | 2023 | 2175 | 2322 | 2472 | 2626 | 2804 |
| | 120 | 2191 | 2348 | 2521 | 2681 | 2845 | 3039 |
| | 132 | 2352 | 2529 | 2705 | 2883 | 3062 | 3270 |
| | 144 | 2503 | 2706 | 2897 | 3092 | 3275 | 3508 |
| | 156 | 2664 | 2886 | 3092 | 3290 | | |
| 168 | 2819 | 3068 | 3280 | 3492 | | | |
| 180 | 2973 | 3252 | 3467 | 3694 | | | |

FABRIC SURCHARGES

ADD

Scotchgard Stain Protector (Not available on Prelude)

\$48

Debut 1/2" Single Cell Print Fabric

Includes: Homespun, Country Woven, Florance, Strata, Angel Hair, Blossom, Terrazzo and Strie

20%

Symphony Fabric

Symphony Prints and Duotones

20%

Symphony Double Cell Flame Resistant

30%

HARDWARE UPGRADE SURCHARGES* AND ACCESSORIES

ADD

Two Moving Rails

\$169

5-10 Foot Expandable Pole - Black

\$54

Comfortex Skylight and Greenhouse Shades

PRICING

LIGHT FILTERING FABRICS

Debut 1/2" Single Cell
Debut 3/4" Single Cell
Premiere 3/4"

Symphony 3/8"
Double Cell

PRICE GROUP 20 Balcony Skylight Shading System

| | | Width In Inches | | | | |
|------------------|-----|-----------------|------|-----|------|------|
| | | 24 | 30 | 36 | 42 | 48 |
| Length In Inches | 36 | 476 | 541 | 603 | 674 | 735 |
| | 42 | 503 | 577 | 655 | 724 | 806 |
| | 48 | 528 | 616 | 694 | 778 | 865 |
| | 54 | 564 | 654 | 740 | 827 | 938 |
| | 60 | 584 | 691 | 785 | 877 | 1004 |
| | 66 | 616 | 722 | 825 | 922 | 1071 |
| | 72 | 654 | 761 | 861 | 963 | 1130 |
| | 78 | 691 | 791 | 900 | 1004 | |
| | 84 | 731 | 828 | 940 | 1046 | |
| | 90 | 777 | 861 | 978 | | |
| 96 | 814 | 896 | 1020 | | | |

All fabrics are not available in all widths, lengths and applications. Refer to Size Specifications on page 10 for availability.

Product Information: See page 77 for detailed information.

- Shades are built with color coordinating hardware and white track.
- Designer metallic and fabric wrapped rails are available.

| FABRIC SURCHARGES | | ADD |
|---|--|------|
| Scotchgard Stain Protector (Not available on Prelude) | | \$48 |
| Debut 1/2" Single Cell Print Fabric | Includes: Homespun, Country Woven, Florance, Strata, Angel Hair, Blossom, Terrazzo and Strie | 20% |
| Symphony Fabric | Symphony Prints and Duotones | 20% |
| | Symphony Double Cell Flame Resistant | 30% |
| HARDWARE UPGRADE SURCHARGES AND ACCESSORIES | | ADD |
| Metallic Hardware | | \$30 |
| Fabric Wrapped Rails | | \$48 |
| 3 Foot Expandable Pole - Silver | | \$30 |
| 5-10 Foot Expandable Pole - Black | | \$54 |

Comfortex Skylight and Greenhouse Shades

PRICING

BLACKOUT FABRICS

Premiere 3/4"
 Symphony 3/8" Double Cell

PRICE GROUP 21

Balcony Skylight Shading System

| | | Width In Inches | | | | |
|------------------|------|-----------------|------|------|------|------|
| | | 24 | 30 | 36 | 42 | 48 |
| Length In Inches | 36 | 618 | 703 | 785 | 876 | 953 |
| | 42 | 654 | 749 | 850 | 944 | 1047 |
| | 48 | 686 | 801 | 903 | 1011 | 1124 |
| | 54 | 732 | 849 | 963 | 1074 | 1218 |
| | 60 | 760 | 899 | 1019 | 1141 | 1305 |
| | 66 | 801 | 940 | 1073 | 1199 | 1391 |
| | 72 | 849 | 990 | 1118 | 1251 | 1467 |
| | 78 | 899 | 1027 | 1171 | 1305 | |
| | 84 | 948 | 1078 | 1219 | 1359 | |
| | 90 | 1010 | 1118 | 1270 | | |
| 96 | 1057 | 1163 | 1326 | | | |

- Product Information:** See page 77 for detailed information.
- Shades are built with color coordinating hardware and white track.
 - Designer metallic and fabric wrapped rails are available.

| FABRIC SURCHARGES | | ADD |
|--|--------------------------------------|---------|
| Scotchgard Stain Protector <i>(Not available on Prelude)</i> | | \$48 |
| Symphony Fabric | Symphony Prints and Duotones | Add 20% |
| | Symphony Double Cell Flame Resistant | Add 30% |
| HARDWARE UPGRADE SURCHARGES AND ACCESSORIES | | ADD |
| Metallic Hardware | | \$30 |
| Fabric Wrapped Rails | | \$48 |
| 3 Foot Expandable Pole - Silver | | \$30 |
| 5-10 Foot Expandable Pole - Black | | \$54 |

Comfortex Skylight and Greenhouse Shades

PRICING

LIGHT FILTERING FABRICS

Debut 1/2" Single Cell
Debut 1/2" Double Cell
Debut 3/4" Single Cell

Premiere 1/2"
Premiere 3/4"
Symphony 3/8"

PRICE GROUP 22

Mezzo Motorized Skylights - White Rail and White Tracks

| | | Width In Inches | | | | |
|------------------|----|-----------------|-----|------|------|------|
| | | 24 | 30 | 36 | 42 | 48 |
| Length In Inches | 36 | 592 | 673 | 752 | 844 | 916 |
| | 42 | 628 | 718 | 815 | 904 | 1005 |
| | 48 | 663 | 770 | 867 | 970 | 1079 |
| | 54 | 702 | 815 | 925 | 1032 | 1167 |
| | 60 | 731 | 861 | 977 | 1097 | 1254 |
| | 66 | 770 | 900 | 1027 | 1154 | 1338 |
| | 72 | 815 | 952 | 1074 | 1200 | 1410 |

Be sure to add the Simplicity motor surcharges and upgrades to the grid above. Shades and motors are priced separately to ensure that percent surcharges apply only to the shade and not the motor.

Product Information: See page 77 for detailed information.

- Mezzo Shades are built with white rail and white track.

| FABRIC SURCHARGES | | ADD | |
|--|---|------------------|------------|
| Scotchgard Stain Protector <i>(Not available on Prelude)</i> | | \$48 | |
| Debut 1/2" Single Cell Print Fabric | Includes: Homespun, Country Woven, Florance, Strata, Angel Hair, Blossom, Terrazzo and Strie | 20% | |
| Debut 1/2" Double Cell Print Fabric Debut 3/4" Single Cell Print Fabric | Includes: Homespun, Country Woven, Florance, Strata and Angel Hair | 20% | |
| Premiere Fabric Prints | Includes: Homespun, Country Woven, Florance, Spheres, Strata, Tuscan Scroll, Angel Hair, Blossom, and Gradients | 20% | |
| Symphony Fabric | Symphony Prints and Duotones | 20% | |
| | Symphony Double Cell Flame Resistant | 30% | |
| MOTORIZATION - HARDWARE UPGRADE SURCHARGES AND ACCESSORIES | | MORE INFO | ADD |
| Simplicity - Motor and Rechargeable Battery Pack | | Pg 52 | \$300 |
| Simplicity 14 Channel White Remote | | Pg 58 | \$50 |
| 48" Extension Wire: | | Pg 58 | \$10 |
| Simplicity Smart Controller (NEO) | | Pg 61 | \$280 |
| 7.4v Solar Panel & Mounting Brackets | | Pg 55 | \$120 |
| Plug-In Charger for 7.4V Li-Ion Rechargeable Battery Pack | | Pg 54 | \$30 |

Comfortex Skylight and Greenhouse Shades

PRICING

ROOM DARKENING & BLACKOUT FABRICS

Premiere 1/2"

Premiere 3/4"

Symphony 3/8"

PRICE GROUP 23

Mezzo Motorized Skylights - White Rail and White Tracks

| | | Width In Inches | | | | |
|------------------|----|-----------------|------|------|------|------|
| | | 24 | 30 | 36 | 42 | 48 |
| Length In Inches | 36 | 769 | 874 | 978 | 1096 | 1190 |
| | 42 | 815 | 932 | 1061 | 1177 | 1308 |
| | 48 | 862 | 1001 | 1128 | 1262 | 1403 |
| | 54 | 912 | 1059 | 1203 | 1341 | 1517 |
| | 60 | 948 | 1118 | 1268 | 1426 | 1629 |
| | 66 | 1001 | 1171 | 1335 | 1500 | 1741 |
| | 72 | 1059 | 1238 | 1397 | 1560 | 1835 |

Be sure to add the Simplicity motor surcharges and upgrades to the grid above.

Product Information: See page 79 rail and white track.

| FABRIC SURCHARGES | | ADD | |
|--|---|-----------|-------|
| Scotchgard Stain Protector (Not available on Prelude) | | \$48 | |
| Premiere Fabric Prints | Includes: Homespun, Country Woven, Florance, Spheres, Strata, Tuscan Scroll, Angel Hair, Blossom, and Gradients | Add 20% | |
| MOTORIZATION - HARDWARE UPGRADE SURCHARGES AND ACCESSORIES | | MORE INFO | ADD |
| Simplicity - Motor and Rechargeable Battery Pack | | Pg 52 | \$300 |
| Simplicity 14 Channel White Remote | | Pg 58 | \$50 |
| 48" Extension Wire: | | Pg 58 | \$10 |
| Simplicity Smart Controller (NEO) | | Pg 61 | \$280 |
| 7.4v Solar Panel & Mounting Brackets | | Pg 55 | \$120 |
| Plug-In Charger for 7.4V Li-Ion Rechargeable Battery Pack | | Pg 54 | \$30 |

French Door Décor Shades
PRICING

LIGHT FILTERING FABRICS

Debut 1/2" Single Cell Premiere 1/2"
 Debut 1/2" Double Cell Premiere 3/4"
 Debut 3/4" Single Cell Symphony 3/8"

PRICE GROUP 24
Non-Movable French Door Décor

| | | Width In Inches | | |
|------------------|-----|-----------------|-----|-----|
| | | 24 | 30 | 36 |
| Length In Inches | 36 | 155 | 175 | 198 |
| | 42 | 166 | 189 | 212 |
| | 48 | 176 | 202 | 230 |
| | 54 | 187 | 214 | 247 |
| | 60 | 200 | 229 | 261 |
| | 66 | 209 | 244 | 280 |
| | 72 | 219 | 255 | 296 |
| | 78 | 230 | 268 | 310 |
| | 84 | 238 | 281 | 323 |
| | 90 | 251 | 294 | 341 |
| 96 | 257 | 305 | 355 | |

Product Information: See page 82 for detailed information.

| FABRIC SURCHARGES | | ADD |
|--|---|------------|
| Scotchgard Stain Protector <i>(Not available on Prelude)</i> | | \$48 |
| Debut 1/2" Single Cell Print Fabric | Includes: Honespun, Country Woven, Florance, Strata, Angel Hair, Blossom, Terrazzo and Strie | 20% |
| Premiere Fabric Prints | Includes: Honespun, Country Woven, Florance, Spheres, Strata, Tuscan Scroll, Angel Hair, Blossom, and Gradients | 20% |
| Symphony Fabric | Symphony Prints and Duotones | 20% |
| | Symphony Double Cell Flame Resistant | 30% |
| HARDWARE UPGRADE SURCHARGES AND ACCESSORIES | | ADD |
| Metallic Hardware | | \$30 |
| Fabric Wrapped Rails | | \$48 |

French Door Décor Shades
PRICING

LIGHT FILTERING FABRICS

Debut 1/2" Single Cell
 Debut 1/2" Double Cell
 Debut 3/4" Single Cell

Premiere 1/2"
 Premiere 3/4"
 Symphony 3/8"

PRICE GROUP 25
Movable French Door Décor

| | | Width In Inches | | |
|------------------|-----|-----------------|-----|-----|
| | | 24 | 30 | 36 |
| Length In Inches | 36 | 275 | 310 | 351 |
| | 42 | 296 | 336 | 380 |
| | 48 | 313 | 360 | 411 |
| | 54 | 334 | 381 | 437 |
| | 60 | 355 | 408 | 472 |
| | 66 | 375 | 432 | 502 |
| | 72 | 393 | 457 | 528 |
| | 78 | 411 | 482 | 556 |
| | 84 | 427 | 503 | 583 |
| | 90 | 448 | 525 | 611 |
| 96 | 463 | 544 | 636 | |

Product Information: See page 82 for detailed information.

| FABRIC SURCHARGES | | ADD |
|--|---|------------|
| Scotchgard Stain Protector <i>(Not available on Prelude)</i> | | \$48 |
| Debut 1/2" Single Cell Print Fabric | Includes: Homespun, Country Woven, Florance, Strata, Angel Hair, Blossom, Terrazzo and Strie | 20% |
| Premiere Fabric Prints | Includes: Homespun, Country Woven, Florance, Spheres, Strata, Tuscan Scroll, Angel Hair, Blossom, and Gradients | 20% |
| Symphony Fabric | Symphony Prints and Duotones | 20% |
| | Symphony Double Cell Flame Resistant | 30% |
| HARDWARE UPGRADE SURCHARGES AND ACCESSORIES | | ADD |
| Top Down-Bottom Up | | \$108 |
| Metallic Hardware | | \$30 |
| Fabric Wrapped Rails | | \$48 |

French Door Décor Shades
PRICING

ROOM DARKENING & BLACKOUT FABRICS

PRICE GROUP 26
Non-Movable French Door Décor

Premiere 1/2"
 Premiere 3/4"
 Symphony 3/8"

| | | Width In Inches | | |
|------------------|-----|-----------------|-----|-----|
| | | 24 | 30 | 36 |
| Length In Inches | 36 | 202 | 226 | 257 |
| | 42 | 216 | 246 | 275 |
| | 48 | 229 | 263 | 299 |
| | 54 | 242 | 277 | 321 |
| | 60 | 259 | 298 | 339 |
| | 66 | 272 | 316 | 365 |
| | 72 | 284 | 331 | 384 |
| | 78 | 299 | 348 | 403 |
| | 84 | 310 | 368 | 422 |
| | 90 | 327 | 381 | 443 |
| 96 | 335 | 398 | 461 | |

Product Information: See page 82 for detailed information.

| FABRIC SURCHARGES | | ADD |
|--|---|------------|
| Scotchgard Stain Protector <i>(Not available on Prelude)</i> | | \$48 |
| Premiere Fabric Prints | Includes: Honespun, Country Woven, Florance, Spheres, Strata, Tuscan Scroll, Angel Hair, Blossom, and Gradients | 20% |
| Symphony Fabric | Symphony Prints and Duotones | 20% |
| | Symphony Double Cell Flame Resistant | 30% |
| HARDWARE UPGRADE SURCHARGES AND ACCESSORIES | | ADD |
| Metallic Hardware | | \$30 |
| Fabric Wrapped Rails | | \$48 |

French Door Décor Shades

PRICING

ROOM DARKENING & BLACKOUT FABRICS

Premiere 1/2"

Premiere 3/4"

Symphony 3/8"

PRICE GROUP 27

Movable French Door Décor

| | | Width In Inches | | |
|------------------|----|-----------------|-----|-----|
| | | 24 | 30 | 36 |
| Length In Inches | 36 | 356 | 403 | 456 |
| | 42 | 384 | 437 | 493 |
| | 48 | 406 | 471 | 534 |
| | 54 | 434 | 496 | 568 |
| | 60 | 461 | 530 | 613 |
| | 66 | 488 | 562 | 653 |
| | 72 | 511 | 595 | 686 |
| | 78 | 534 | 626 | 722 |
| | 84 | 555 | 654 | 758 |
| | 90 | 583 | 681 | 794 |
| | 96 | 601 | 709 | 827 |

Product Information: See page 82 for detailed information.

| FABRIC SURCHARGES | | ADD |
|--|---|------|
| Scotchgard Stain Protector <i>(Not available on Prelude)</i> | | \$48 |
| Premiere Fabric Prints | Includes: Honespun, Country Woven, Florance, Spheres, Strata, Tuscan Scroll, Angel Hair, Blossom, and Gradients | 20% |
| Symphony Fabric | Symphony Prints and Duotones | 20% |
| | Symphony Double Cell Flame Resistant | 30% |
| HARDWARE UPGRADE SURCHARGES AND ACCESSORIES | | ADD |
| Top Down-Bottom Up | | \$85 |
| Metallic Hardware | | \$30 |
| Fabric Wrapped Rails | | \$48 |



Standard Hardware



**7.4V Rechargeable
Simplicity Motorization**



Cord Loop Hardware



**7.4V Rechargeable
Powertouch**



Cordless Ultra Hardware



Ovation Hardware



**Cordless Lift & Lock
Hardware**



**Insulating Slumbershades
Hardware**



**12V Non-Rechargeable
Simplicity Motorization**



**Specialty Shape
Hardware**

Cellular Shade Collection

STANDARD CORD LOCK SHADES HARDWARE SYSTEM

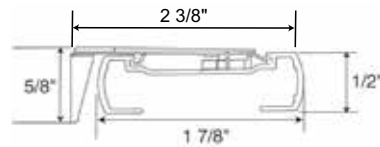
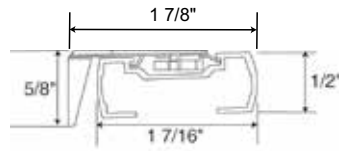
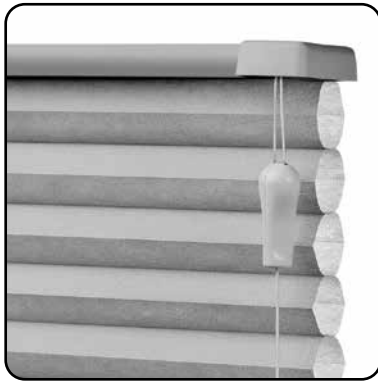

Standard Cord Lock Rail

- Depth of rail: 1 7/16"
- Depth of rail and bracket: 1 7/8"
- Height of rail: 1/2"
- Height of bracket: 5/8"

Deluxe Cord Lock Rail

- Depth of rail: 1 7/8"
- Depth of rail and bracket: 2 3/8"
- Height: 1/2"
- Height of bracket: 5/8"

| Hardware Features | |
|---|---|
| Hardware colors for Cellular fabrics | Color coordinated head and bottom rails with white cord and tassel |
| Standard Hardware for all Custom Graphics | White head and bottom rails with white cord and tassel |
| Upgrades | |
| Fabric Wrapped Upgrade | Fabric used is same fabric as the shade. Back of rail is white to outside. Color coordinated end caps. |
| Designer Metallic Upgrade | <ul style="list-style-type: none"> • Oil Rubbed Bronze head and bottom rails, bronze colored tassel, bronze end caps and white cord. |

| Mounting Dimensions | Standard Cord Lock Rail | Deluxe Cord Lock Rail |
|---|--|------------------------------|
| Minimum Shallow Mount | 3/4" | 3/4" |
| Minimum Flush Inside Mount | 2" | 2 3/8" |
| Minimum Outside Mount | 3/4" | 3/4" |
| Minimum Side Mount | 1 1/8" | 1 3/8" |
| Minimum Flush Side Mount | 1 5/8" | 1 7/8" |
| Recommended Side Mounting Method | <ul style="list-style-type: none"> • See figure B (pg 45) for recommended mounting method for side mount shades • Width limit for side mount brackets is 48" | |

Finished Dimensions

| Inside and Side Mount | |
|---|--|
| | <ul style="list-style-type: none"> • Fabric will measure ordered width less: 3/8" • Head rail* will measure ordered width less: 3/16" |
| Outside Mount | |
| | <ul style="list-style-type: none"> • Fabric will measure ordered width • Head rail* will measure ordered width plus: 3/16" |
| Exact (End Cap to End Cap) Mount | |
| | <ul style="list-style-type: none"> • Fabric will measure ordered width less: 3/16" • Head rail* will measure ordered width |
| Cord Length | |
| | <ul style="list-style-type: none"> • Comfortex complies with all WCMA/ANSI standards and as such the default cord length will be 40% of the ordered shade length. Custom lengths are available. |
| * Head rail measurements include endcaps. Width and length measurements may vary +/- 1/8" | |

Cellular Shade Collection

STANDARD CORD LOCK SHADES HARDWARE SYSTEM

There are two sizes of the cord lock hardware: Standard and Deluxe.

Standard size hardware is used on all fabrics except ¾" Premiere, Linen Weave, Debut, Verona and Boutique Fabrics which use the Deluxe size.

- Standard Rectangular
- Two-On-One Head Rail
- Door Decor
- SlumberShades
- Top Down - Bottom Up
- Day-Night
- Specialty Shapes
- Balcony

Deluxe Hardware is standard on ¾" Premiere, Linen Weave, Debut, Verona and Boutique Fabrics.

- Standard Rectangular
- SlumberShades
- Two-On-One Head Rail
- Top Down - Bottom Up
- Specialty Shapes

Recommended Mounting Method for Side Mount Shades | Maximum Width 48"

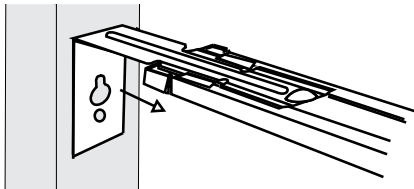

Figure B

EZ Level on Cellular Shades

EZ Level makes quick work of leveling without cords to cut or tuck into a rail. See page 91 for details.

Things to Consider

- If child safety is a concern, consider cordless options: Cordless Ultra, Cordless Lift & Lock or Motorization.
- Larger shades can be difficult to operate. Consider Cord Loop, Cordless Ultra or Motorization hardware.
- If privacy is an issue, consider Top Down-Bottom Up options.

Ordering Information Standard Cord Lock Shades

Standard Rectangular

- Specify LB or OB mount, rail color and left or right lift cord.

Top Down - Bottom Up

- Specify LB or OB mount and rail color. Middle rail will match the head and bottom rails.
- Top Down - Bottom Up Shades are made with two operating cord locks, one on the left and one on the right side of shade. The right cord operates the middle rail and left cord operates the bottom.

Two-On-One Head Rail

Two-On-One Head Rail Shades operate as two separate shades on one head rail.

- Specify LB or OB mount.
- Specify panel sizes.
- Maximum width in a single panel depends on fabric type. See page 2 for maximum single panel width.
- ⅜" Space between panels.
- Fabric wrapped Two-On-One Shades will have a seam in the center of the rail due to the wide width.

Specialties (Arches, Trapezoids, Octagons and Quarter Rounds)

See pages 68-74 for more information.

Balcony Skylight Shading System

See pages 77-78 for more information.

Door Decor

See pages 82-83 for more information.

Insulating SlumberShades

See pages 66-67 for more information.

Day-Night Shades

See pages 84-85 for more information.

Cellular Shade Collection

CORD LOOP HARDWARE SYSTEM

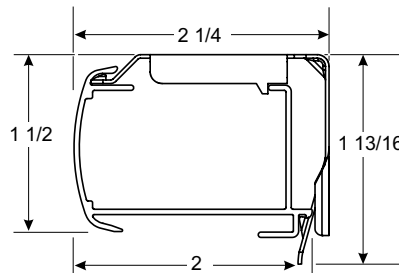

Cord Loop Rail Dimensions

- Depth of rail: 2"
- Depth of rail and bracket: 2 1/4"
- Height of rail: 1 1/2"
- Height of bracket: 1 13/16"

| Hardware Features | |
|---|--|
| Hardware colors for Cellular fabrics | Color coordinated head, bottom rails and end caps with a white cord and tensioner |
| Standard Hardware for all Custom Graphics | White head and bottom rails with white cord |
| Upgrades | |
| Fabric Wrapped Upgrade | Fabric used is same fabric as the shade. Back of rail is white to outside. Color coordinated end caps for bottom rails, head rail has white clutch cover and end caps. |
| Designer Metallic Upgrade | <ul style="list-style-type: none"> • Smooth faced Oil Rubbed Bronze head, bottom rails and end caps with bronze tensioner and bronze cord. |

| Mounting Dimensions | Cord Loop Hardware System |
|---|--|
| Minimum Shallow Mount | 1/2" |
| Minimum Flush Inside Mount | 2 1/4" |
| Minimum Outside Mount | 7/8" |
| Minimum Side Mount | 1 1/4" |
| Minimum Flush Side Mount | 2 1/4" |
| Recommended Side Mounting Method | <ul style="list-style-type: none"> • See figure A (pg 47) for recommended mounting method for side mount shades • Width limit for side mount brackets is 48" |

| Finished Dimensions | |
|----------------------------------|---|
| Inside Mount | |
| | <ul style="list-style-type: none"> • Fabric will measure ordered width less: 3/8" • Head rail* will measure ordered width less: 3/16" |
| Outside Mount | |
| | <ul style="list-style-type: none"> • Fabric will measure ordered width • Head rail* will measure ordered width plus: 3/16" |
| Side Mount | |
| | <ul style="list-style-type: none"> • Fabric will measure ordered width less: 7/8" • Head rail* will measure ordered width less: 1 1/16" |
| Exact (End Cap to End Cap) Mount | |
| | <ul style="list-style-type: none"> • Fabric will measure ordered width less: 3/16" • Head rail* will measure ordered width |

* Head rail measurements include endcaps. Width and length measurements may vary +/- 1/8"

Cellular Shade Collection

CORD LOOP HARDWARE SYSTEM

Applications

- Standard Rectangular
- Two-On-One Head Rail
- Top Down - Bottom Up
- SlumberShades

Cord Loop Hardware System Features

Cord loops are available 2' to 15' lengths in 1' intervals. Please specify length when ordering. Standard loop sizes are as follows:

| Shade Length | Standard Loop |
|--|---------------|
| Up to and including 26 ⁷ / ₈ " | 1' (12") |
| 27" to 39 ⁷ / ₈ " | 2' (24") |
| 40" to 59 ⁷ / ₈ " | 3' (36") |
| 60" to 83 ⁷ / ₈ " | 4' (48") |
| 84" to 107 ⁷ / ₈ " | 5' (60") |
| 108" and greater | 6' (72") |

Cord loops over 6' in length will be white.

Recommended Mounting Method for Side Mounting Shades

Width limit for side mount brackets is 48".

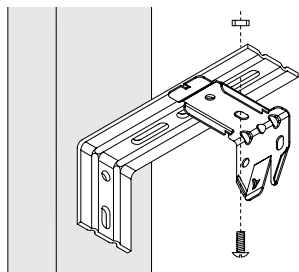

Figure A

Refer to the installation instructions on Comfortex.com/comfortex-dealers or the OnDemand Mobile Library for further details on side mounting shades.

Ordering Information for Cord Loop Hardware Shades

Standard Rectangular

- Specify IB or OB mount, rail color and left or right loop cord.
- Specify cord loop length when ordering.

Top Down - Bottom Up

- Specify IB or OB mount and rail color. Middle rail will match the top and bottom rails.
- Specify cord loop length when ordering.
- Controls are the right cord loop operates the middle rail and left cord loop operates the bottom. Reverse controls are not available.

Two-On-One Head Rail

- Two-On-One Head Rail Shades operate as two separate shades on one head rail.
- Specify IB or OB mount and rail color.
- Specify panel sizes.
- Specify cord loop length when ordering.
- Maximum width in a single panel depends on fabric type. See page 74 for maximum single panel width.
- ³/₈" Space between panels.
- Fabric wrapped Two-On-One Shades will have a seam in the center of the rail due to the wide width.

Insulating SlumberShades

See pages 66-67 for more information.

EZ Level on Cellular Shades

EZ Level makes quick work of leveling without cords to cut or tuck into a rail. See page 91 for details.

Cellular Shade Collection

CORDLESS ULTRA HARDWARE SYSTEM

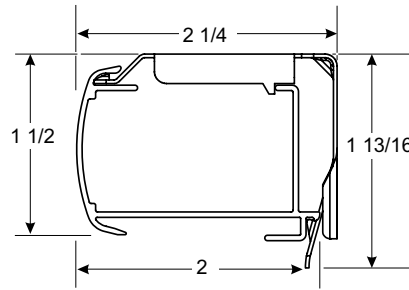

Cord Loop Rail Dimensions

- Depth of rail: 2"
- Depth of rail and bracket: 2 1/4"
- Height of rail: 1 1/2"
- Height of bracket: 1 13/16"

| Hardware Features | |
|---|---|
| Hardware colors for all Cellular fabrics (Symphony Blackout Not Available) | Color coordinated head, bottom rails and end caps |
| Standard Hardware for all Custom Graphics | White head, bottom rails and end caps |
| Upgrades | |
| Fabric Wrapped Upgrade | Fabric used is same fabric as the shade. Back of rail is white to outside. End caps on fabric wrapped head and bottom rails are color coordinated |
| Designer Metallic Upgrade | <ul style="list-style-type: none"> • Smooth faced Oil Rubbed Bronze head, bottom rails and end caps |
| Mounting Dimensions | |
| Cord Loop Hardware System | |
| Minimum Shallow Mount | 1/2" |
| Minimum Flush Inside Mount | 2 1/4" |
| Minimum Outside Mount | 7/8" |
| Minimum Side Mount | 1 1/4" |
| Minimum Flush Side Mount | 2 1/4" |
| Recommended Side Mounting Method | <ul style="list-style-type: none"> • See figure A on page 47 for recommended mounting method for side mount shades • Width limit for side mount brackets is 48" |
| Finished Dimensions | |
| Inside Mount | |
| | <ul style="list-style-type: none"> • Fabric will measure ordered width less: 3/8" • Head rail* will measure ordered width less: 3/16" |
| Outside Mount | |
| | <ul style="list-style-type: none"> • Fabric will measure ordered width • Head rail* will measure ordered width plus: 3/16" |
| Side Mount | |
| | <ul style="list-style-type: none"> • Fabric will measure ordered width less: 7/8" • Head rail* will measure ordered width less: 1 1/16" |
| Exact (End Cap to End Cap) Mount | |
| | <ul style="list-style-type: none"> • Fabric will measure ordered width less: 3/16" • Head rail* will measure ordered width |

* Head rail measurements include endcaps. Width and length measurements may vary +/- 1/8"

Cellular Shade Collection

CORDLESS ULTRA HARDWARE SYSTEM

Applications

- Standard Rectangular
- Top Down - Bottom Up
- Insulating SlumberShades
- Two-On-One Head Rail

Things to Consider

- Is the top of your window out of reach? You can order an extension pole to reach but it can still be tricky. You may want to consider Cord Loop or Motorized hardware.
- For shades mounted on doors, you may want to order hold down brackets.
- If privacy is an issue, consider Top Down-Bottom Up options.

Ordering Information for Cordless Ultra Hardware Shades

Standard Rectangular

- Specify IB or OB mount and rail color.

Top Down - Bottom Up

- Specify IB or OB mount and rail color. Middle rail will match the head and bottom rails.

Insulating SlumberShades

See pages 66 for more information.

Accessories

- 3' Expandable Pole - Silver:
- 5-10' Expandable Pole - Black:



3' Pole

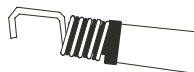

5-10' Pole End

Specially designed pole end fits into the handle on the bottom rail and allows for easy operation.

Cordless Ultra and Cordless Ultra Top Down - Bottom Up Hardware Features

- Children and pets have safer surroundings in homes that have window shades without operating cords, reducing the risk of strangulation.
- Cordless Ultra and Cordless Ultra Top Down - Bottom Up Shades can be raised or lowered with a gentle push or pull on the rail handle.
- Cordless Ultra Top Down - Bottom Up Shades feature two moving rails.
- Order an operating pole for out of reach applications.

Cordless Ultra Shade Operation

Cordless shades should be operated from the handle located in the center of the bottom rail. Using the handle will aid in smooth and easy shade operation. Two handles are supplied on wider width shades.

To lower the shade, pull down on the handle which is secured to the bottom rail and guide the rail to desired position (Figure A). For out of reach applications, an optional extension pole should be used.

To raise the shade, push the bottom rail up using the handle on the bottom rail and guide the rail to the desired position. The shade will hold any position when the bottom rail is released. Raise the shade slowly and steadily to allow the shade to stack evenly (Figure B).

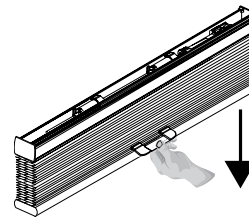

Figure A

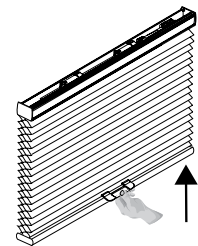

Figure B

New Sleek 3' Pole

Optional



Recommended Mounting Method for Side Mounting Shades

See Page 47.

EZ Level on Cellular Shades

EZ Level makes quick work of leveling without cords to cut or tuck into a rail. See page 91 for details.

Cellular Shade Collection

CORDLESS LIFT & LOCK HARDWARE SYSTEM

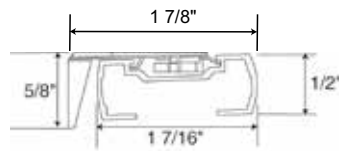

Standard Top Rail

- Depth of rail: 17/16"
- Depth of rail and bracket: 17/8"
- Height of rail: 1/2"
- Height of bracket: 5/8"

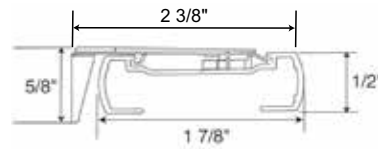

Deluxe Top Rail

- Depth of rail: 17/8"
- Depth of rail and bracket: 23/8"
- Height: 1/2"
- Height of bracket: 5/8"

| Hardware Features | | |
|---|--|------------------|
| Hardware colors for all Cellular fabrics | Color coordinated head, middle and bottom rails with color coordinated push button/handle on the middle and bottom rails | |
| Standard Hardware for all Custom Graphics | White head, middle and bottom rails with white cord | |
| Upgrades | | |
| Fabric Wrapped Upgrade | Fabric used is same fabric as the shade. Back of rail is white to outside. All shades will have a color coordinated push button and handle on the middle /bottom rail. Color coordinated end caps. | |
| Designer Metallic Upgrade | <ul style="list-style-type: none"> • Oil Rubbed Bronze head, middle, bottom rails and end caps. • Oil Rubbed Bronze push button/handle on the middle and bottom rails. | |
| Mounting Dimensions | | |
| Mounting Method | Standard Head Rail | Deluxe Head Rail |
| Minimum Shallow Mount | 3/4" | 3/4" |
| Minimum Flush Inside Mount | 2" | 2 1/2" |
| Minimum Outside Mount | 3/4" | 3/4" |
| Minimum Side Mount | 1 1/8" | 1 3/8" |
| Minimum Flush Side Mount | 1 5/8" | 1 7/8" |
| Recommended Side Mounting Method | <ul style="list-style-type: none"> • See figure A (pg 47) for recommended mounting method for side mount shades • Width limit for side mount brackets is 48" | |
| Finished Dimensions | | |
| Inside and Side Mount | | |
| | <ul style="list-style-type: none"> • Fabric will measure ordered width less: 3/8" • Head rail* will measure ordered width less: 3/16" | |
| Outside Mount | | |
| | <ul style="list-style-type: none"> • Fabric will measure ordered width • Head rail* will measure ordered width plus: 3/16" | |
| Exact (End Cap to End Cap) Mount | | |
| | <ul style="list-style-type: none"> • Fabric will measure ordered width less: 3/16" • Head rail* will measure ordered width | |
| * Head rail measurements include endcaps. Width and length measurements may vary +/- 1/8" | | |

Cellular Shade Collection

CORDLESS LIFT & LOCK HARDWARE SYSTEM

Cordless Lift & Lock Shades Hardware System Bottom Rail Dimensions

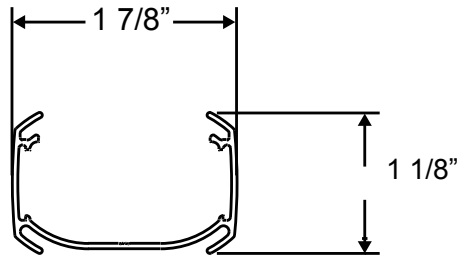

- Depth of rail: $1\frac{7}{8}$ "
- Height of rail: $1\frac{1}{8}$ "

Applications

- Standard Rectangular
- Top Down-Bottom Up
- Two-On-One Headrail

Standard size head rail hardware is used on $\frac{1}{2}$ " and $\frac{3}{8}$ " fabrics. These fabrics include: $\frac{1}{2}$ " Debut (all), $\frac{1}{2}$ " Premiere, Symphony, and Symphony Blackout.

Deluxe size head rail hardware is used on $\frac{3}{4}$ " Premiere, Linen Weave, Verona, Boutique and $\frac{3}{4}$ " Debut.

The bottom rail is the same size for all fabrics.

- Two-On-One headrail price as 2 separate shades and add \$66 (not available in Top Down-Bottom Up)

Important Operating Note on Cordless Lift & Lock Shades

- To operate a Cordless Lift & Lock Shade, the middle or bottom rails must be accessible. An extension pole is not available for Cordless Lift & Lock Shades.

Cordless Lift & Lock Hardware Features

- Children and pets have safer surroundings in homes that have window shades without operating cords, reducing the risk of strangulation.
- Cordless Lift & Lock Shades can be raised or lowered by pressing the button located on the bottom rail and guiding the rail into the desired location.

Things to Consider

- Is the top of your window out of reach? To operate a Cordless Lift & Lock Shade, the bottom rail must be accessible. If the bottom or middle rail is not accessible, you may want to consider Cord Loop, Cordless Ultra or Motorized hardware. An extension pole is not available for Cordless Lift & Lock Shades.
- For shades mounted on doors, you may want to order hold down brackets.

Ordering Information for Cordless Lift & Lock Shades

Standard Rectangular

- Specify IB or OB mount and rail color.

Cordless Lift & Lock Shade Operation

Cordless Lift & Lock Shades are operated using the push button handle located in the center of the bottom rail.

To raise or lower the shade; press the button on the shade handle, and guide the rail to desired position. Release the button to lock the shade into place.

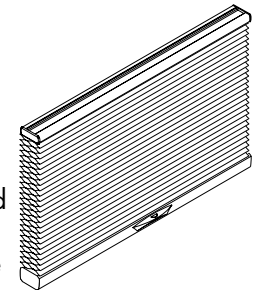

The shade will hold any position when the button is released. Raise the shade slowly and steadily to allow the shade to stack evenly.

NOTE: Lift and Lock shades do not utilize the EZ Level plugs like other Comfortex rectangular shade hardware systems. The bottom rail equalization can be adjusted using the tie-off plugs on the top of the headrail. Middle rail of TDBU has an adjusting tool inside the rail. Access by removing the right side endcap.

Cellular Shade Head Rail Options

12V NON-RECHARGEABLE SIMPLICITY MOTORIZED CELLULAR SHADES

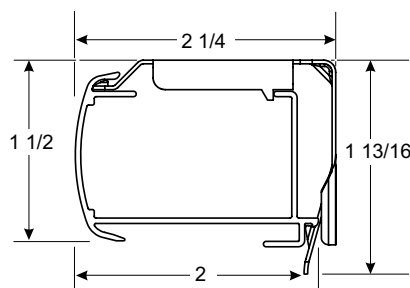
**Simplicity Motorized Rail Dimensions**

- Depth of rail: 2"
- Depth of rail and bracket: 2 1/4"
- Height of rail: 1 1/2"
- Height of bracket: 1 13/16"

Hardware Features

| | |
|---|--|
| Hardware colors for all Cellular fabrics | Color coordinated head, bottom rails and end caps |
| Standard Hardware for all Custom Graphics | White head and bottom rails and end caps |
| Simplicity Remote | Upper and lower limit stops pre-programmed, Intermediate stop "favorites" position can be set on-site. |

Upgrades

| | |
|---------------------------|---|
| Fabric Wrapped Upgrade | Fabric used is same fabric as the shade. Back of rail is white to outside. End caps on fabric wrapped head and bottom rails are color coordinated |
| Designer Metallic Upgrade | <ul style="list-style-type: none"> • Smooth faced Oil Rubbed Bronze head, bottom rails and end caps |

Mounting Dimensions**Simplicity Motorized Hardware System**

| | |
|---|---|
| Minimum Shallow Mount | 1/2" |
| Minimum Flush Inside Mount | 2 1/4" |
| Minimum Outside Mount | 7/8" |
| Minimum Side Mount | 1 1/4" |
| Recommended Side Mounting Method | <ul style="list-style-type: none"> • See page 47 for recommended mounting method for side mount shades • Width limit for side mount brackets is 48" |

Finished Dimensions**Inside Mount**

- Fabric will measure ordered width less: 3/8"
- Head rail* will measure ordered width less: 3/16"

Outside Mount

- Fabric will measure ordered width
- Head rail* will measure ordered width plus: 3/16"

Side Mount

- Fabric will measure ordered width less: 7/8"
- Head rail* will measure ordered width less: 1 1/16"

Exact (End Cap to End Cap) Mount

- Fabric will measure ordered width less: 3/16"
- Head rail* will measure ordered width

* Head rail measurements include endcaps. Width and length measurements may vary +/- 1/8"

Cellular Shade

12V NON-RECHARGEABLE SIMPLICITY MOTORIZED CELLULAR SHADES

Simplicity Motors

The Simplicity Motor program features a battery powered 12V motor utilizing a single battery wand or plug-in DC transformer. Simplicity motors are compact and use a radio frequency remote to raise or lower the shades.

Motorized Lift Systems are not offered on sizes within the shaded area on the Standard Rectangular price grids.

- Length measurements may vary +/- 1/8".

Applications

- Standard Rectangular
- Two-On-One Head Rail Bottom Up

EZ Level

[Learn about the EZ Level feature on page 91.](#)

Simplicity Motorization Surcharges

The standard Simplicity Motorized Lift System surcharge includes a 12 volt battery wand with eight AA alkaline batteries. Remotes are needed to operate the shades. See pricing pages.

Important Simplicity Motorized Shade Operating and Installation Information

- Simplicity Motorized Shades installed into windows with metal casings may have a reduced radio frequency range, or may not operate at all, depending on the application.
- Do not let the antenna on the motor touch any metal objects. This may interfere with signals from the remote control.

Simplicity Battery Wand

Batteries are needed to operate Simplicity motors. The battery wand can be clipped to the head rail or wall or ceiling mounted utilizing white battery wand clips. The 12 volt battery wand measures 17 1/4", and comes with eight AA alkaline batteries, and is white in color.

The battery wire is 10" long. A 48" extension wire is available.



Simplicity Motor Battery Life and Replacement

Eight alkaline batteries are included with the wand. The battery life will vary based on the type of window covering selected, the size and weight of the window covering and the number of times you operate the shade on a daily basis. For example, a 36" x 60" single honeycomb shade operated twice daily will commonly have a battery life which lasts up to 18 months.

Comfortex will warranty batteries for up to 3 months from date of purchase.

Simplicity Hand Held Remote 14 Channel Remote

The TDBU remote has 14-channels. This remote is required for TDBU motorization but can be utilized on all Simplicity motorized shades. Each channel has a setting to operate the middle rail and a setting to operate the bottom rail. The TDBU remote is required for TDBU motors. The **14 Channel TDBU remote** can operate up to fourteen shades individually or 14 groups. Simplicity Rechargeable Motorized Cellular Shades are programmed at the factory with the "up and down" limits. The shades are **UNLINKED** from the remote so they are not able to operate during shipping. Each shade should be installed **after** linking it to the remote.



Simplicity TDBU remotes and holders are white or black in color. The remote comes with a holder which can be mounted to a wall for easy storage. The range of the remote is approximately 80 feet.

DC Power Supply/Transformer

12 Volt DC power supply/transformer is available and requires a standard power outlet to power the motor. The transformer is an alternative to a battery wand. Each transformer can power a single shading. The power supply must plug in to the motor. The DC power supply is black and comes with a 80" wire. The dimensions are 1 7/8" wide x 3 1/4" long x 1 1/4" deep



12V Simplicity Low Voltage Hardwiring System

[Learn about the 12V Low Voltage Hardwiring System on page 60.](#)

SIMPLICITY MOTORIZATION PRICING EXAMPLE:

| | |
|----------------------------------|-----------------|
| Debut 1/2" | |
| Light Filtering 42" x 60" Shade: | \$417.00 |
| Simplicity Motor Surcharge: | \$300.00 |
| Simplicity Remote Control: | \$50.00 |
| Total List Price: | \$767.00 |

Cellular Shade Collection

7.4V RECHARGEABLE SIMPLICITY MOTORIZED HARDWARE SYSTEM

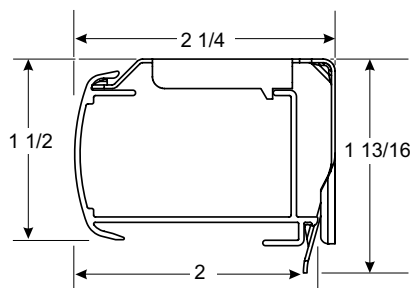
**Rechargeable Simplicity Rail Dimensions**

- Depth of rail: 2"
- Depth of rail and bracket: 2 1/4"
- Height of rail: 1 1/2"
- Height of bracket: 1 13/16"

Hardware Features

| | |
|---|---|
| Hardware colors for all Cellular fabrics | Color coordinated head, bottom rails and end caps |
| Standard Hardware for all Custom Graphics | White head and bottom rails and end caps |

Upgrades

| | |
|---------------------------|---|
| Fabric Wrapped Upgrade | Fabric used is same fabric as the shade. Back of rail is white to outside. End caps on fabric wrapped head, middle and bottom rails are color coordinated |
| Designer Metallic Upgrade | <ul style="list-style-type: none"> • Smooth faced Oil Rubbed Bronze head, middle, bottom rails and end caps |

Mounting Dimensions**Rechargeable Simplicity Motorization Hardware System**

| | |
|---|---|
| Minimum Shallow Mount | 1/2" |
| Minimum Flush Inside Mount | 2 1/4" |
| Minimum Outside Mount | 7/8" |
| Minimum Side Mount | 1 1/4" |
| Minimum Flush Side Mount | 2 1/4" |
| Recommended Side Mounting Method | <ul style="list-style-type: none"> • See page 47 for recommended mounting method for side mount shades • Width limit for side mount brackets is 48" |

Finished Dimensions**Inside Mount**

- Fabric will measure ordered width less: 3/8"
- Head rail* will measure ordered width less: 3/16"

Outside Mount

- Fabric will measure ordered width
- Head rail* will measure ordered width plus: 3/16"

Side Mount

- Fabric will measure ordered width less: 7/8"
- Head rail* will measure ordered width less: 1 1/16"

Exact (End Cap to End Cap) Mount

- Fabric will measure ordered width less: 3/16"
- Head rail* will measure ordered width

* Head rail measurements include endcaps. Width and length measurements may vary +/- 1/8"

Cellular Shade Collection

7.4V RECHARGEABLE SIMPLICITY MOTORIZED HARDWARE SYSTEM

Rechargeable Simplicity Motors

The Simplicity Motor program features a battery powered motor utilizing a rechargeable battery hidden inside the shade head rail. Simplicity motors are compact and use a radio frequency remote to raise or lower the shades.

Rechargeable Motorized Lift Systems are not offered on sizes within the shaded area on the Standard Rectangular price grids.

Applications

- Standard Rectangular
- Top Down-Bottom Up see page 57
- Two-On-One Head Rail Bottom Up

EZ Level

Learn about the EZ Level feature on page 91.

Rechargeable Simplicity Motorization Surcharges

The Rechargeable Simplicity Motorized Lift System surcharge includes a rechargeable battery. Remotes are needed to operate the shades. Refer to pricing pages.

Important Simplicity Motorized Shade Operating and Installation Information

- Simplicity Motorized Shades installed into windows with metal casings may have a reduced radio frequency range, or may not operate at all, depending on the application.
- Do not let the antenna on the motor touch any metal objects. This may interfere with signals from the remote control.

Simplicity Rechargeable Battery

The rechargeable battery is concealed in the head rail of the shade. A charger is required for the rechargeable battery. The rechargeable battery comes fully charged from the factory.



Charging Port on Back of Head rail.

RECHARGEABLE SIMPLICITY PRICING EXAMPLE:

| | |
|------------------------------------|-----------------|
| Debut 1/2" | |
| Light Filtering 42" x 60" Shade: | \$417.00 |
| Simplicity Rechargeable Surcharge: | \$300.00 |
| Charger for Rechargeable : | \$30.00 |
| Simplicity Remote Control: | \$50.00 |
| Solar Panel & Mounting Brackets: | \$120.00 |
| Total List Price: | \$917.00 |

Solar Panel Recharge Option

Plugs in to any Simplicity Rechargeable Remote control shade (does not work with PowerTouch)

Provides constant trickle charge to 7.4v Li-Ion Rechargeable battery packs. Will prolong the life of the charge of the 7.4v rechargeable battery packs, and in some applications will maintain charge indefinitely.

Life of charge is subject to application variables such as, size and weight of shade, frequency of use, amount of direct sunlight exposure, etc.

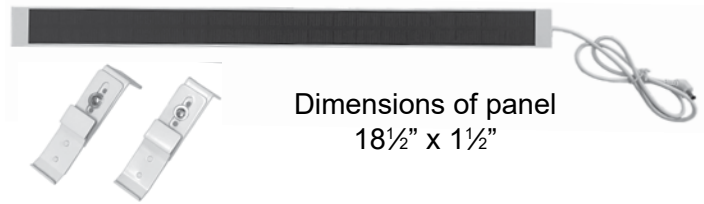

Dimensions of panel
18 1/2" x 1 1/2"

- Solar Panel with Mounting Brackets: \$120.00

Solar Recharge Optimum Application

- Full direct sunlight (minimum 2 hours per day) to maintain full charge. Based on one operation cycle per day (one open, one close).
- Excessive duration of cloudy weather will impact the rate of charge.
- Avoid any obstructions including mullions and screens.

Solar Panel Mounting

Bottom portion of the bracket may be lowered if needed for more sun exposure. Bracket can be mounted behind or next to shade mounting bracket.

Bracket Method

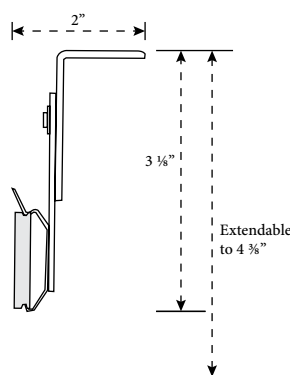

Tape Method

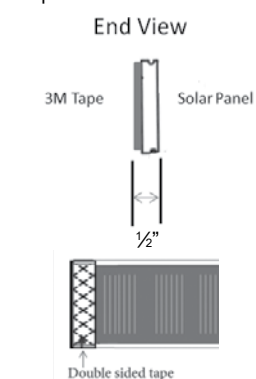

Tape goes on the face (black side) of the panel.

If the solar panel is mounted directly behind the headrail at the top of the window, you need to make sure that the solar panel does not interfere with the shade mounting brackets also. The solar panel can go between brackets spaced apart, or behind brackets if the depth of the window casing allows.

Cellular Shade Collection

7.4V RECHARGEABLE SIMPLICITY MOTORIZED HARDWARE SYSTEM

Simplicity Rechargeable Battery Life

Rechargeable batteries are included with the motor.

The average battery charge will last 6-12 months based on an average sized shade raised and lowered once per day. The life of the battery charge will vary based on the type of window covering selected, the size and weight of the window covering and the number of times the shade is operated on a daily basis.

The battery can be recharged up to 500 times. It takes approximately 5 hours to recharge the motor when fully depleted.

Ordering Information for Rechargeable Motorized Cellular Shades

Simplicity Motor Option

- Specify IB or OB mount and rail color.
- Specify remote and other accessories if needed.
- Specify one or more battery chargers.

Please Note:

- Not all motors run at the same rate of speed.
- Simplicity motors have a "Favorites" position setting. If the homeowner wants to set several shades at the same intermediate position, follow instructions provided with installation manual.
- Simplicity Rechargeable Motorized Cellular Shades are programmed at the factory with the "up and down" limits. The shades are **UNLINKED** from the remote so they are not able to operate during shipping. Each shade should be installed **after** linking it to the remote.
- The Simplicity remotes utilize one 3V battery. Batteries are included. Comfortex will warranty batteries for up to 3 months from date of purchase.
- **REMEMBER: Order at least one charger if ordering rechargeable motors.**

Simplicity Motorized Shade Warranty

Please see Policy PDF for complete Comfortex warranty information.

Battery Charger

8.4 Volt charger requires a standard power outlet to recharge the battery. You must specify charger when ordering a Simplicity Rechargeable Shade. The charger plugs into the charger port. The charger is black and comes with a 156" wire. The dimensions are 1" wide x 2½" length x 1¾" deep.



Simplicity Hand Held Remote

14 Channel Remote

The TDBU remote has 14-channels. This remote is required for TDBU motorization but can be utilized on all Simplicity motorized shades. Each channel has a setting to operate the middle rail and a setting to operate the bottom rail. The TDBU remote is required for TDBU motors. The **14 Channel TDBU remote** can operate up to fourteen shades individually or 14 groups. Simplicity Rechargeable Motorized Cellular Shades are programmed at the factory with the "up and down" limits. The shades are **UNLINKED** from the remote so they are not able to operate during shipping. Each shade should be installed **after** linking it to the remote.



Simplicity TDBU remotes and holders are white or black in color. The remote comes with a holder which can be mounted to a wall for easy storage. The range of the remote is approximately 80 feet.

Simplicity Motor Hand Held Remotes Operation

Press the up or down button on the remote to raise or lower the shade to your desired position.

To reprogram channel assignments, please refer to the installation instructions and/or view the video at: comfortex.com/comfortex-dealers.

Cellular Shade Collection

7.4V RECHARGEABLE MOTORIZED TOP DOWN-BOTTOM UP HARDWARE SYSTEM

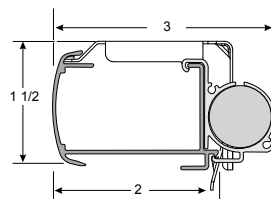
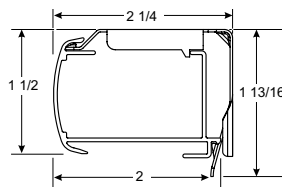
**Simplicity Motorized Rail Dimensions**

- Depth of rail: 2"
- Depth of rail and bracket: 2 1/4"
- Height of rail: 1 1/2"
- Height of bracket: 1 13/16"

Simplicity Motorized Rail with External Battery Dimensions (shades under 36")

- Depth of rail: 2"
- Depth of rail, bracket & battery: 3"
- Height of rail: 1 1/2"
- Height of bracket: 1 13/16"

| Hardware Features | |
|---------------------------|--|
| Standard Hardware | • Color coordinated head, middle, and bottom rails. |
| 14 Channel TDBU Remote | Upper and lower limit stops pre-programmed |
| Upgrades | |
| Designer Metallic Upgrade | • Smooth faced Designer Oil Rubbed Bronze head, middle, bottom rails and end caps |
| Fabric Wrapped Rails | • Fabric used to cover the rails is the same fabric as the shade. The back of the rail will be white to the outside. End Caps will be color coordinated. |

| Mounting Dimensions | Simplicity Motorized Hardware System |
|---|---|
| Minimum Shallow Mount | 1/2" |
| Minimum Flush Inside Mount | 2 1/4" |
| Minimum Outside Mount | 7/8" |
| Minimum Side Mount | 1 1/4" |
| Recommended Side Mounting Method | <ul style="list-style-type: none"> • See page 47 for recommended mounting method for side mount shades • Width limit for side mount brackets is 48" |

Finished Dimensions

| Inside Mount | |
|---|---|
| | <ul style="list-style-type: none"> • Fabric will measure ordered width less: 3/8" • Head rail* will measure ordered width less: 3/16" |
| Outside Mount | |
| | <ul style="list-style-type: none"> • Fabric will measure ordered width • Head rail* will measure ordered width plus: 3/16" |
| Side Mount | |
| | <ul style="list-style-type: none"> • Fabric will measure ordered width less: 7/8" • Head rail* will measure ordered width less: 1 1/16" |
| Exact (End Cap to End Cap) Mount | |
| | <ul style="list-style-type: none"> • Fabric will measure ordered width less: 3/16" • Head rail* will measure ordered width |

* Head rail measurements include endcaps. Width and length measurements may vary +/- 1/8"

Cellular Shade Collection

7.4V RECHARGEABLE MOTORIZED TOP DOWN-BOTTOM UP HARDWARE SYSTEM

Rechargeable Simplicity Motors

The Simplicity TDBU Motor program features a battery powered motor utilizing a rechargeable battery hidden inside the shade head rail. If shades are less than 36" in width, an external snap-on battery pack is necessary.

(See picture to right)

Applications

- TDBU Rectangular/ Two-On-One Head Rail

EZ Level

Learn about the EZ Level feature on page 91.

Rechargeable Simplicity Motorization Surcharges

The Rechargeable Simplicity Motorized Lift System surcharge includes a rechargeable battery. Remotes are needed to operate the shades. Refer to pricing pages.

Ordering Information for Top Down-Bottom Up Motorized Cellular Shades

Simplicity Motor Option

- Specify IB or OB mount and rail color.
- 14 Channel TDBU Remote is required.
- Specify one or more battery chargers.

Please Note:

- Shades that are 24"-36" in width will have an external battery.
- Shades with an external battery and OB mounted will need spacer blocks.
- Simplicity Rechargeable Motorized Cellular Shades are programmed at the factory with the "up and down" limits.
- **REMEMBER: Order at least one charger if ordering rechargeable motors.**

Top Down-Bottom Up Simplicity Motor Hand Held 14 Channel Remote

The TDBU remote has 14-channels. Each channel has a setting able to operate the middle rail and a setting able to operate the bottom rail. The TDBU remote is required for TDBU motors, but can be used with other motors as well. The **14 Channel TDBU remote** can operate up to fourteen shades individually or 14 groups. Simplicity Rechargeable Motorized Cellular Shades are programmed at the factory with the "up and down" limits. The shades are **UNLINKED** from the remote so they are not able to operate during shipping. Each shade should be installed **after** linking it to the remote.

Simplicity TDBU remotes and holders are white in color. The remote comes with a holder which can be mounted to a wall for easy storage. The range of the remote is approximately 80 feet. A **14 Channel (14C) remote** can be utilized on all Simplicity motorized shades.



Simplicity Rechargeable Battery for TDBU

The rechargeable battery is concealed in the head rail of the shade. A charger is required for the rechargeable battery. The rechargeable battery comes fully charged from the factory.

Rechargeable Battery Pack is concealed in the head rail. Minimum width 36" or less is required otherwise battery wand must be mounted externally.

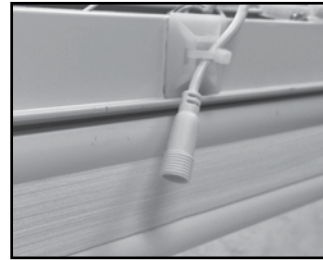

Charging Port on Back of Head rail.

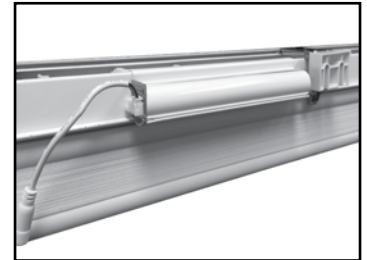

Snap-On external battery for TDBU shades 36" or less in width. Spacer block also required for outside mount.

Battery Charger

8.4 Volt charger requires a standard power outlet to recharge the battery. You must specify charger when ordering a Simplicity Rechargeable Shade. The charger plugs into the charger port. The charger is black and comes with a 156" wire. The dimensions are 1" wide x 2 1/2" length x 1 3/4" deep.



Solar Panel Recharge Option

Plugs in to any Simplicity Rechargeable Remote control shade (does not work with PowerTouch). See page 55.

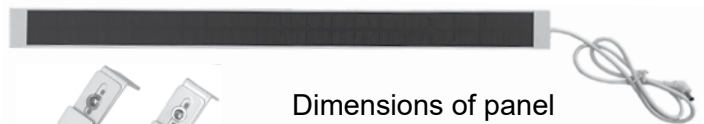

Dimensions of panel
18 1/2" x 1 1/2"

MOTORIZED TOP DOWN-BOTTOM UP PRICING EXAMPLE:

| | |
|----------------------------------|------------------|
| Debut 1/2" | |
| Light Filtering 42" x 60" Shade: | \$417.00 |
| Simplicity Rechargeable | |
| TDBU Surcharge: | \$515.00 |
| Charger for Rechargeable: | \$30.00 |
| TDBU Remote Control: | \$50.00 |
| Total List Price: | \$1012.00 |

Cellular Shade Collection

7.4V RECHARGEABLE SIMPLICITY HARDWARE SYSTEM

EZ Charge Extension Wand Option

EZ Charge Extension Wand is the newest innovation in rechargeable motorization. Easily charge your hard to reach Simplicity Rechargeable Shades with the EZ Charge Extension Wand to charge. The wand extends up to 31" in length.

Simple to use! Place the magnetized wand tip to the receiving port to attach. Then plug the charger into the base of the wand. It is that simple!

- EZ Charge Extension Wand can be easily concealed by a valance or drapery panel.
- Great for out of reach windows

EZ Charge Wall Mount Receiver

- The EZ Charge Wall Mount Receiver includes screws and anchors. These can be used for wood or drywall mounting.
- Extension cable plugs into charging port of Simplicity Rechargeable shades.

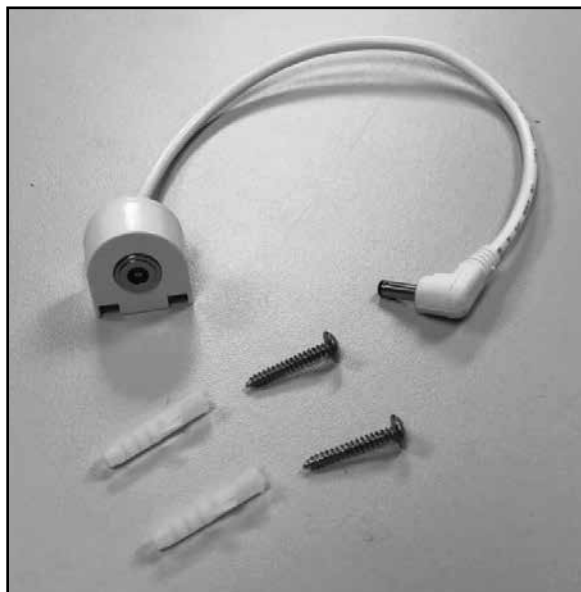

EZ Charge Wall Mount Receiver Kit | CKIT078
 One kit per Simplicity Motorized shade is needed.

EZ Charge Wand

- Wand is 9½" and extends to 31" Magnetized tip makes connection quick and easy.
- Once wand is in place plug the 8.4v charger into the bottom of the extension wand for charging.

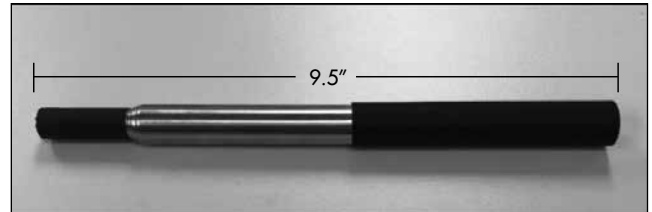

EZ Charge Wand | CKIT077
 Order with the EZ Charge Wall Mount Receiver Kit



EZ Charge Receiving Port



Port/Wand Connection

| Shade/Blind Product | EZ Charge Wall Mount Receiver <u>List Price</u> | EZ Charge Wand <u>List Price</u> |
|---------------------|---|----------------------------------|
| Cellular | \$18 | \$32 |



Battery Charger



Wand Base

Battery Charger - SOLD SEPARATELY

You must specify charger when ordering a Simplicity Rechargeable Motorized Shade. The charger plugs into the wand base. The 8.4 Volt charger requires a standard power outlet to recharge the motor. The charger is black and comes with a 156" wire. The dimensions are 1" wide x 2½" length x 1¾" deep.

Cellular Shade Collection

12V SIMPLICITY LOW VOLTAGE HARDWIRING SYSTEM

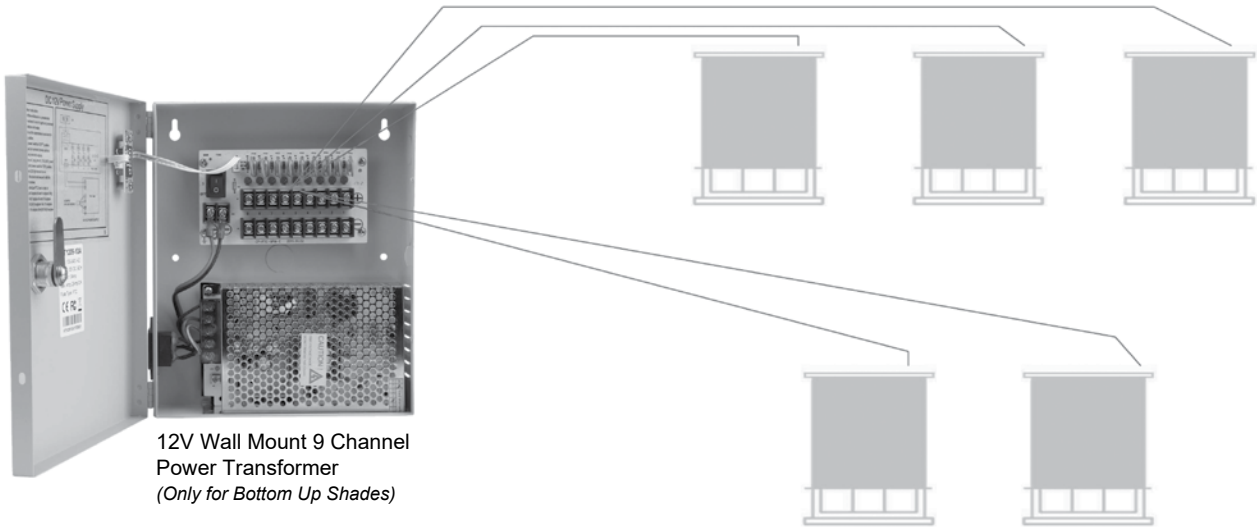

12V Low Voltage Hard Wired

Low Voltage hardwire powered motors are available for Cellular bottom up shades. The system offers a maintenance-free power option for Simplicity Motorized Shades. Our Simplicity power transformer mounts in a safe dry location (such as your basement), out of sight, and provides power for up to nine individual shades per box.

2 Conductor wires (not included) should be pre-installed by a licensed contractor according to local building codes, to connect power from the transformer to the shades.

Simply connect the wire adapters provided to connect the power wire to the Simplicity motor power input on the back of the shade, then connect the pre-run wires to the (+ / -) terminal block in the transformer box, and flip on the power switch.

- Product Dimension: 7.875" wide, 9.4" Tall, 2.45" deep
- Converts incoming 120V AC to outgoing 12V to up to 9 shades.

- **Product Description:**

- 12v10a 9ch
- Input Voltage Range : AC90V-264V
- Input Frequency Range : 50Hz-60Hz
- Output Voltage Range : DC12V+/-5%
- Output Current : 10 Ampere
- Output Power : 120 Watt
- Output Ripple&Noise : ≤42MV
- Output Efficiency : ≥83%
- Output Fuse Type : PTC
- Output Fuse Rating : 2A
- Environment Operatiing Amb.Temp : -30 ~45
20%~90%RH
- Envioment Storage Temp : -40 ~85 10%~95%RH
- Plugs into standard household outlet

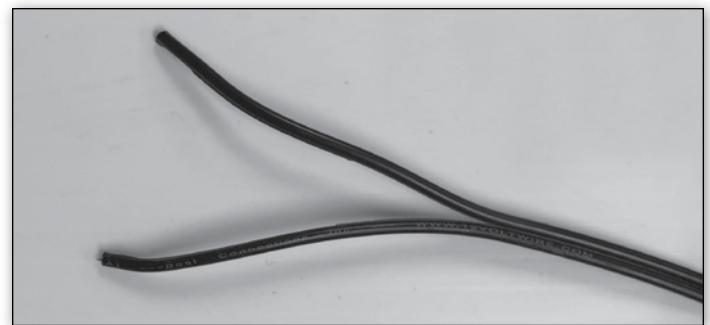

2 Conductor Wires (not included) running to basement 12V Power Transformer

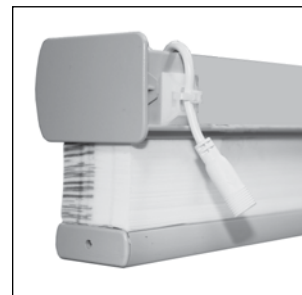

Power port on back of shade

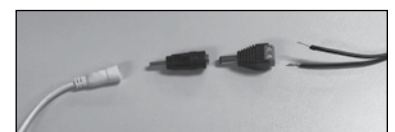

Wires connecting to power port on Simplicity shade: supplied.



12V Wall Mount 9 Channel Power Transformer

Cellular Shade Collection

SIMPLICITY SMART CONTROLLER



Simplicity Smart Controller Dimensions

- Width of controller: 2³/₈"
- Length of controller: 2¹⁵/₁₆"
- Height of controller: 1¹/₈"

Simplicity Smart Controller

- Works with Apple and Android devices
- FREE Downloadable Application
- Compatible with previously installed Simplicity Remote Control Shades
- Powered by NEO Smart Blinds App
- Compatible with Amazon Alexa, Google Assistant systems, Control4 and Savant systems

Simplicity Smart Controller

The Simplicity Smart Controller is a small device that you install in your home that allows you to set automatic opening and closing times for all Simplicity motorized shades as well as the ability to control your motorized shades from a phone, tablet or PC from anywhere in world.

The Simplicity Smart Controller will work with any Comfortex remote motorized shade with Simplicity remote control motors purchased after 2012.

The Simplicity Smart Controller plugs into a standard electrical outlet and connects to WiFi and sends signals to your shades using the same radio frequencies as a normal remote control.

How Does The NEO Smart Blinds App Work?

The app uses WiFi or cellular data to send commands over the internet to the Simplicity Smart Controller.

Do I Need Any Other Equipment?

Yes, The location where your shades are installed must have WiFi in order for the Simplicity Smart Controller to work. Additionally, you must have a smartphone or tablet running Android or iOS (eg. iPhone, iPad, Samsung Galaxy S7) and have the NEO Smart Blinds app. installed.

Why Would I Want A Simplicity Smart Controller?

There are two main ways the Simplicity Smart Controller adds additional value to your motorized shades. First, once all of your shades have been added, you can use your smartphone as a single remote for all of your shades that will work anywhere you are regardless of distance from the shade. Secondly, the device allows you to set schedules so your motorized shades automatically open and close without needing to do anything on a day to day basis.

Do I Need To Buy More Than 1 Controller?

The normal use for the Simplicity Smart Controller is to plug it in out of the way and forget it. Since it has roughly the same range as a remote you will want enough devices to allow all shades to be operated without moving the controller. So depending on the layout of the home and location of the shade, you might want multiple devices to have convenient full home coverage.

How Far Is The Range Of A Controller?

You should see a range of approximately 150 ft. However this number might be less depending on the layout of your home. In general we recommend one per a floor of a normal sized home.

Can I Control My Shades From Multiple Devices?

Yes! You can download the NEO Smart Blinds App onto multiple devices, After installing the App. on a new device simply log in with the same email/password on each device and you will have access to control your shades.

Can It Be Used With Already Installed Shades?

Yes! Simply follow the directions in the NEO Smart Blinds app. to add a shade. At the pairing step you can put the shade in pairing mode using the primary remote control (or by accessing the button on the shades motor). Adding the shade to the NEO Smart Blinds App. will not affect the normal remote operation.

How Much Does The NEO Smart Blinds App Cost?

The App is a free download, However you must have at least one Simplicity Smart Controller to serve as a bridge between the App and your shades.

Cellular Shade Collection

7.4V RECHARGEABLE POWERTOCH MOTORIZED HARDWARE SYSTEM

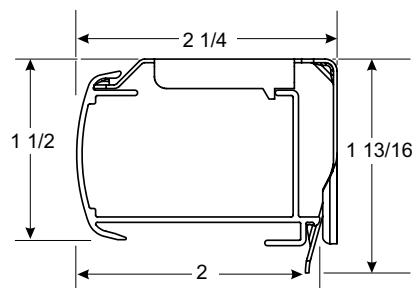
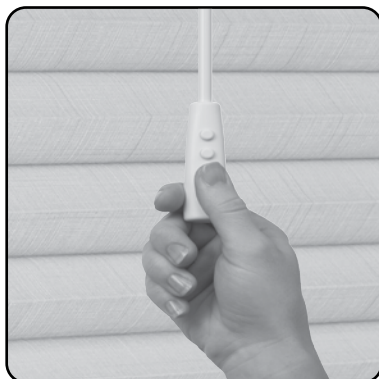
**Simplicity Motorized Rail Dimensions**

- Depth of rail: 2"
- Depth of rail and bracket: 2 1/4"
- Height of rail: 1 1/2"
- Height of bracket: 1 13/16"

Hardware Features

| | |
|--|---|
| Hardware colors for all Cellular and Pleated fabrics | Color coordinated head, bottom rails and end caps |
| Standard Hardware for all Custom Graphics | White head and bottom rails and end caps |
| Simplicity Remote | Upper and lower limit stops pre-programmed, Intermediate stop "favorites" position can be set on site |

Upgrades

| | |
|---------------------------|---|
| Fabric Wrapped Upgrade | Fabric used is same fabric as the shade. Back of rail is white to outside. End caps on fabric wrapped head, middle and bottom rails are color coordinated |
| Designer Metallic Upgrade | <ul style="list-style-type: none"> • Smooth faced Oil Rubbed Bronze head, bottom rails and end caps |

Mounting Dimensions**Simplicity Motorized Hardware System**

| | |
|---|---|
| Minimum Shallow Mount | 1/2" |
| Minimum Flush Inside Mount | 2 1/4" |
| Minimum Outside Mount | 7/8" |
| Minimum Side Mount | 1 1/4" |
| Minimum Flush Side Mount | 2 1/4" |
| Recommended Side Mounting Method | <ul style="list-style-type: none"> • See page 47 for recommended mounting method for side mount shades • Width limit for side mount brackets is 48" |

Finished Dimensions**Inside Mount**

| | |
|--|---|
| | <ul style="list-style-type: none"> • Fabric will measure ordered width less: 3/8" • Head rail* will measure ordered width less: 3/16" |
|--|---|

Outside Mount

| | |
|--|--|
| | <ul style="list-style-type: none"> • Fabric will measure ordered width • Head rail* will measure ordered width plus: 3/16" |
|--|--|

Side Mount

| | |
|--|---|
| | <ul style="list-style-type: none"> • Fabric will measure ordered width less: 7/8" • Head rail* will measure ordered width less: 1 1/16" |
|--|---|

Exact (End Cap to End Cap) Mount

| | |
|--|--|
| | <ul style="list-style-type: none"> • Fabric will measure ordered width less: 3/16" • Head rail* will measure ordered width |
|--|--|

* Head rail measurements include endcaps. Width and length measurements may vary +/- 1/8"

Cellular Shade Collection

7.4V RECHARGEABLE POWERTOCH MOTORIZED HARDWARE SYSTEM

PowerTouch™ Rechargeable Shades

Cellular Shades can be fabricated with the PowerTouch Rechargeable Push Button Control option. The PowerTouch Rechargeable option is an easy, cord free motorized operation for the budget savvy homeowner. PowerTouch Rechargeable uses Simplicity motors and components.

PowerTouch Rechargeable Shades Operation

Press the up or down button on the pendant to raise or lower the shading to your desired position.

No programming is required with PowerTouch™, all programming is set at the factory. Upper and lower limits can easily be adjusted in the field if desired. Please refer to the installation instructions at comfortex.com/comfortex-dealers. A "favorites" or intermediate stop position can be set once installed.

PowerTouch Rechargeable Surcharges

See page 15.

PowerTouch Appearance

- The PowerTouch wand and pendant is attached to the head rail when installed.
- The wand and pendant hangs down the front of the shades from the head rail. The wand does not touch the fabric.
- Pendant is 2½" long.
- The pendant does not need to be mounted to the wall to operate the shade.



PowerTouch Rechargeable Color Options

- Shades with Black or Oil Rubbed Bronze hardware will be built with black wand and pendants standard. All other colors will use white wand and pendants.



White



Black Shown with Plug-In Charger

PowerTouch Wand and Pendant Location

The standard location for the wand and pendant is on the right. Please specify location when ordering.

PowerTouch Rechargeable Wand Length

- The standard length of the wand will measure the indicated below unless otherwise specified.

| Shading Length | Standard Wand Length |
|----------------|----------------------|
| Up to 30" | 1' (12") |
| >30" to 52" | 2' (24") |
| >52" to 78" | 3' (36") |
| >78" to 100" | 4' (48") |
| >100" to 120" | 5' (60") |

Mounting Requirements for PowerTouch Rechargeable Shades

- No special installation hardware or wiring requirements are needed.

Battery Charger

8.4 Volt charger requires a standard power outlet to recharge the battery. You must specify charger when ordering a Simplicity Rechargeable Shade. The charger plugs into the charger port. The charger is black and comes with a 156" wire. The dimensions are 1" wide x 2½" length x 1¾" deep.



PowerTouch Rechargeable Shades Warranty

Please see Policy PDF for complete warranty information.

Cellular Shade Collection

OVATION CELLULAR SLIDER HARDWARE SYSTEM

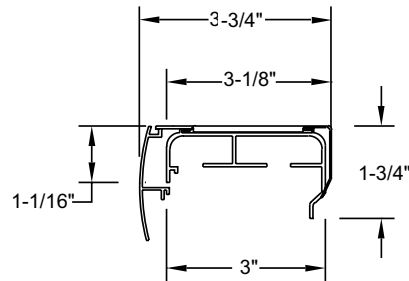

Ovation Hardware Rail Dimensions

- Depth of rail: 3"
- Depth of rail and bracket: 3 1/8"
- Depth of rail, bracket & valance: 3 3/4"
- Height: 1 3/4"

| Hardware Features | |
|----------------------------|--|
| Standard Hardware Color | Aspen White #785 |
| Optional Hardware Colors | Ivory, beige, tan and gray rails are available as an option. Visit comfortex.com to view color options <ul style="list-style-type: none"> • Gardenia White #862 • White Tierra #661 • Silverado #276 |
| Mounting Dimensions | |
| | Ovation Hardware System |
| Minimum Inside Mount | 3/4" |
| Minimum Flush Mount | 3 5/8" |
| Minimum Outside Mount | 5/8" |
| Finished Dimensions | |
| Inside Flush Mount | |
| Track Width: | |
| Right or Left Stack | 3/16" less than ordered width |
| Split Stack | 3/16" less than ordered width |
| Center Stack | 3/16" less than ordered width |
| Finished Slider Length | 1/2" less than ordered length |
| Valance | 3/16" less than ordered width |
| Outside Mount | |
| Track Width | Ordered width |
| Finished Slider Length | Ordered length - No reductions will be made |
| Valance | Ordered width plus 1 1/4" |
| Valance Returns | Will measure 3 1/8" (standard) |

Cellular Shade Collection

OVATION CELLULAR SLIDER HARDWARE SYSTEM

Applications

- Standard Rectangular
- Opens and closes from side to side
- Four stacking options - see below.
- Dual Panel option with a center opening design with two fabrics, one on each side, each spanning the width of the window.

Ovation Stacking Options

Specify stacking configuration when ordering.

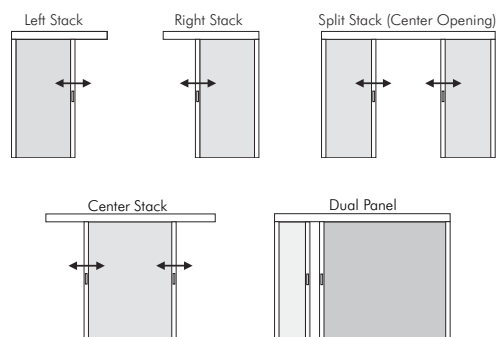

Left: Fabric stacks to the left side of the slider.

Right: Fabric stacks to the right side of the slider.

Center Stack: Center Stack Sliders fabric panels can move fully to the left or the right.

Split Stack: Fabric is split in the center of the slider forming two equal panels which open to opposite ends of the slider. Both panels will be of equal width unless otherwise specified. Split stack is not available with Gradient shades.

* Split stack sliders are available in maximum widths from 240" to 336" (maximum width depends on the fabric selected). If the width exceeds the maximum width of the fabric, it will be fabricated as two separate sliders. The supplied valance will create the appearance of a single slider. Call Customer Service for assistance.

Dual Panel: A Dual Panel Stack Slider has a center opening design with a different fabric on each side, each of which can span the full width of the window. Both panels will be of equal width unless otherwise specified. Specify which fabric stacks to left and which fabric stacks to the right.

Ordering Information for Ovation Cellular Sliders

- Specify IB or OB mount.
- Specify stacking configuration.
 - On Dual Panel Shades, specify which fabric stacks to the left and right.
 - On Split Stack Shades, both panels will be of equal width unless specified.
- Specify valance width and return length.

Ovation Valance Specifications

- Every Ovation Slider is supplied with a painted aluminum valance to match your hardware color choice.
- The valance attaches to the head rail using a durable plastic clip system.

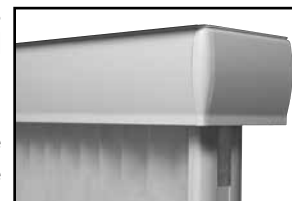

Ovation Valance Dimensions

All valance dimensions are measured on the flat, back side.

- Valance Height: $3\frac{1}{4}"$
- Standard Return Length (OB only): $3\frac{1}{8}"$
- For each spacer block, $\frac{1}{2}"$ will be added to the length of the valance returns. For extension brackets, 2" will be added unless otherwise instructed.
- If the slider requires a non-flush inside mount, you must order a custom valance. Exact valance width and exact valance return length (minimum $1\frac{1}{2}"$) must be specified in the Special Instructions section of the order form.
- Custom returns are available for IB non-flush and OB Cellular Sliders. Please specify return length upon ordering.

Things to Consider

- Since most Ovations are sold in large sizes, the shade will have a large fabric stack. On an outside mount, you may want to order the shade a few inches wider so that the fabric stack can be clear of the window. For more information on Ovation's stack height, see pages 77-78 for information.
- Premiere Custom Design fabrics will be turned 90 degrees on Ovation Shades. The pattern orientation will be left to right since Ovation shades open side to side. Split stack is not available with Gradient shades.
- Symphony double honeycomb fabric may require additional care when opening or closing the shade. Double honeycomb fabric is generally stiffer than single honeycomb material and may offer minor resistance when opening and closing. If this is a concern, Comfortex recommends selecting a coordinating fabric from the Virtuoso or Baritone collections.

The Ultimate Blackout Cellular Shade

INSULATING SLUMBERSHADES HARDWARE SYSTEM

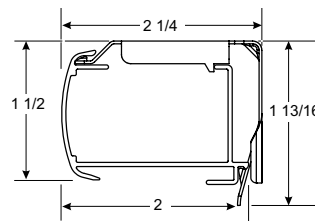
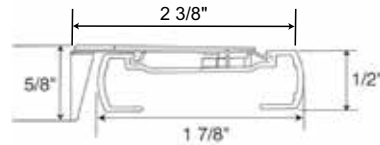
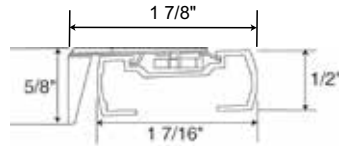

Standard Cord Lock Rail

- Depth of rail: 1⁷/₁₆"
- Depth of rail and bracket: 1⁷/₈"
- Height of rail: 1/2"
- Height of bracket: 5/8"

Deluxe Cord Lock Rail

- Depth of rail: 1⁷/₈"
- Depth of rail and bracket: 2³/₈"
- Height: 1/2"
- Height of bracket: 5/8"

Cord Loop & Cordless Ultra Rail

- Depth of rail: 2"
- Depth of rail and bracket: 2¹/₄"
- Height of rail: 1¹/₂"
- Height of bracket: 1¹³/₁₆"

| Hardware Features | | |
|---|--|---------------------------------|
| Hardware colors for all Cellular fabrics | Color coordinated head, middle, bottom rails and end caps | |
| Blackout Sidetrack Colors Available | White, Tan and Bronze | |
| Upgrades | | |
| Fabric Wrapped Upgrade | Fabric used is same fabric as the shade. Back of rail is white to outside. | |
| Designer Metallic Upgrade | • Oil Rubbed Bronze head, middle, bottom rails and end caps. | |
| Mounting Dimensions (inside mount only) | Standard Head Rail | Deluxe Head Rail |
| Standard Cord Lock (Standard Rectangular and Top Down-Bottom Up) | | |
| Minimum Inside Mount | 1 ¹ / ₂ " | 1 ¹ / ₂ " |
| Minimum Flush Inside Mount | 2" | 2 ³ / ₈ " |
| Cord Loop & Cordless Ultra (Standard Rectangular and Top Down-Bottom Up) | | |
| Minimum Inside Mount | 1 ⁵ / ₈ " | NA |
| Minimum Flush Inside Mount | 2 ¹ / ₄ " | NA |
| Outside, shallow and side mounts are not available. The shade's light blocking ability is compromised by using any other mount than a fully flush mount application. | | |
| Finished Dimensions | | |
| Inside Mount | | |
| | <ul style="list-style-type: none"> • Fabric will measure ordered width less: 7/8" • Head rail and bottom rail will measure ordered width less: 1¹/₁₆" • Sidetrack length will measure ordered length less: 1/8" | |

The widest width of the window cannot exceed the narrowest width of the window by more than 1/4".

Precise width measurements are critical to proper performance of SlumberShade products. Make sure to measure to the nearest 1/16" and provide the **NARROWEST** width measurement along the length of the window. Be sure to measure the top, middle and bottom of the opening. It is very common for the width of a window to vary from top to bottom.

The Ultimate Blackout Cellular Shade

INSULATING SLUMBERSHADES HARDWARE SYSTEM

Insulating SlumberShades Small Track Dimensions

Used with all fabrics standard size head rail.

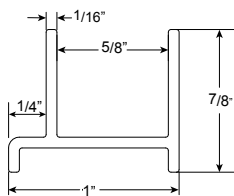

Small Track

- Width of track: 1"
- Height of track: 7/8"

Insulating SlumberShades Large Track Dimensions

Used with all fabrics that utilize the deluxe sized head rail.

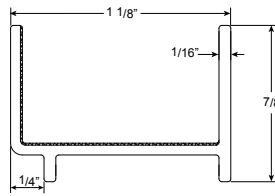

Large Track

- Width of track: 1 1/8"
- Height of track: 7/8"

Applications

- Standard Rectangular
- Top Down - Bottom Up
- Cordless and Cordless Top Down - Bottom Up
- Cord Loop and Top Down - Bottom Up
- Motorization

SlumberShades are for inside mount applications only.

Insulating SlumberShade Fabric

Light Filtering fabrics are available as SlumberShades, however the best light control is achieved by using a blackout cellular fabric.

Ordering Information for Insulating SlumberShades

SlumberShades are for inside mount applications only.

Precise width measurements are critical to proper performance of SlumberShade products. Make sure to measure to the nearest 1/16" and provide the **NARROWEST** width measurement along the length of the window. Be sure to measure the top, middle and bottom of the opening. It is very common for the width of a window to vary from top to bottom. The widest width of the window cannot exceed the narrowest width of the window by more than 1/4".

If you have questions about ordering SlumberShades, contact Comfortex Technical Services at 800-843-4151.

Accessories

- 3' Expandable Pole - Silver: (see pg 26)
- 5-10' Expandable Pole - Black:

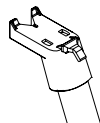

Specially designed pole end fits into the handle on the Cordless Ultra bottom rail and allows for easy operation.

Note: Pole operation with Slumbertrack can cause the rail to tilt and can make smooth operation difficult.

Insulating SlumberShades Features

Use SlumberShades to provide the darkest sleeping environment by sealing out all the light

Energy Saving Blackout Sidetracks

Energy saving blackout sidetracks are made from a durable window grade PVC. The blackout sidetracks seal off the light gap between the blackout cellular shade and the window. The blackout sidetracks feature a black interior lining to absorb light and prevent it from entering the room.



Motorization Options

Learn about the motorization options on pages 129-142.

SlumberShades are easy to install, and feature removable sidetracks that are attached to the window frame with magnets. The sidetracks can be removed for window cleaning. The UV stable, window grade PVC sidetracks are available in white, tan and bronze to match your existing trim.

Please Note: When properly installed, SlumberShades block 99% of all visible light. In certain installations with intense sunlight, a very small amount of light may reflect around the edges of the honeycomb fabric along each side of the shade. This is a normal attribute of the SlumberShade system.

Insulating SlumberShade End Caps

The specially designed notched bottom rail end caps fit over the blackout sidetracks and allow for smooth movement when raising and lowering the shade.

Head and Bottom Rail Seals

To ensure a perfectly dark sleeping environment, additional fuzz seals are supplied to be placed along the shade's bottom rail and between the head rail and the window frame if needed. These barriers provide a complete light stop all the way around the window to keep all exterior light out. Also, these additional seals provide a very effective barrier against heat loss along your windows.

Magnets and fuzz bar are standard on Cordless and Cordless Top Down-Bottom Up Shades to ensure closure between the bottom rail and window sill.

Energy Efficiency

Independent testing has shown SlumberShades provide an R-value greater than 7.0* when installed over a double paned vinyl window. The testing also indicates that the R-value of a SlumberShade is 2.5 to 3 times higher than that of the same shade without sidetracks. The insulating cellular fabric, sidetracks, and fuzzy seal all ensure that the SlumberShades provides superior energy efficiency.

* Independent testing provided by Consortium for Advanced Residential Buildings (CARB), a U.S. Department of Energy Building America research team. Learn more at comfortex.com/comfortex-dealers.

EZ Level

Learn about the EZ Level feature on page 91.

Cellular Specialty Shades

STARBURST ARCHES HARDWARE SYSTEM

Stationary Starburst

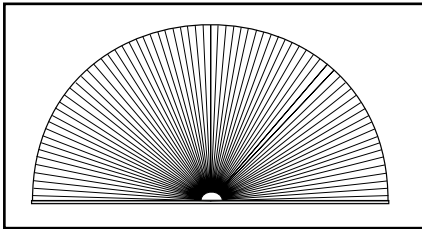

Figure A

Movable Starburst

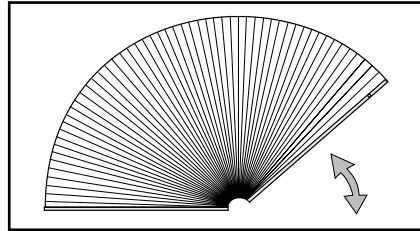

Figure B

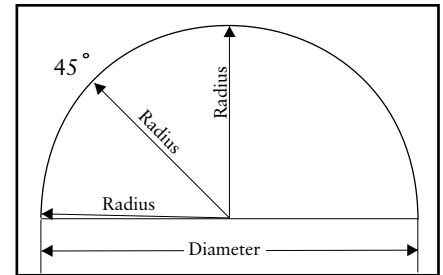

Figure C

| Hardware Features See Page 46 for Rail Dimensions | | |
|---|--|------------------------------|
| Hardware colors | Color coordinated rails | |
| Upgrades | | |
| Fabric Wrapped Upgrade | Fabric used is same fabric as the shade. Back of rail is white to outside. Color coordinated end caps. Please note: On Stationary Starburst Arches the fabric wrap will be spliced in the center of the base rail. | |
| Designer Metallic Upgrade | <ul style="list-style-type: none"> Oil Rubbed Bronze rails with bronze colored end caps. | |
| Mounting Dimensions | | |
| | Standard Cord Lock Rail | Deluxe Cord Lock Rail |
| Minimum Shallow Mount | 3/4" | 3/4" |
| Minimum Flush Inside Mount | 2" | 2 3/8" |
| Recommended Side Mounting Method | <ul style="list-style-type: none"> See page 47 figure B for recommended mounting method for side mount shades Width limit for side mount brackets is 48" | |
| Finished Dimensions | | |
| Inside and Side Mount | | |
| <ul style="list-style-type: none"> Fabric will measure ordered width less: 3/8" Head rail* will measure ordered width less: 3/16" | <ul style="list-style-type: none"> * Head rail measurements include endcaps. Width and length measurements may vary +/- 1/8" | |

Applications

- Stationary Fan Style Arch
 - Movable Fan Style Arch
- Movable Starburst Arch shades are for inside and shallow mount applications only.

Stationary Starburst Features (Figure A)

- All non-perfect Stationary Starburst arches require a template made from brown craft paper.** Comfortex offers template kits. Please contact Customer Service to order. Stock number: 751000, See page 92
- A perfect arch is twice as wide as it is high.
- Stationary Starburst shades which are not perfect half circles must have a height that equals half the width +/- 5".
- Price according to the largest radius measurement. If the height is greater than the width, take height X 2 and use that number to determine pricing.
- When ordering arches as perfect half-circles make sure the radius of the arch remains constant to ensure a proper fit. (See Figure C)

Movable Starburst Features (Figure B)

- Starburst Movable archtop shades are cut to perfect half circles only and do not require a template. The height must be exactly 1/2 the diameter.
- A perfect arch is twice as wide as it is high.
- When ordering arches as perfect half circles make sure the radius of the arch remains constant to ensure a proper fit. (See Figure C)
- The hinge gap (gap between the two rails) is not centered in the window. The moving rail is always smaller than the stationary rail to provide proper movement within the window.

Accessories

- 5-10' Expandable Pole - Black
- Specially designed pole end fits into the handle on movable Starburst Shades for easy operation.



Cellular Specialty Shades

SUNSET ARCHES HARDWARE SYSTEM

Movable Sunset

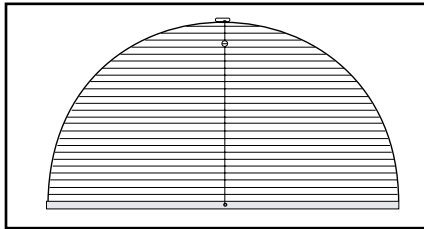

Figure A

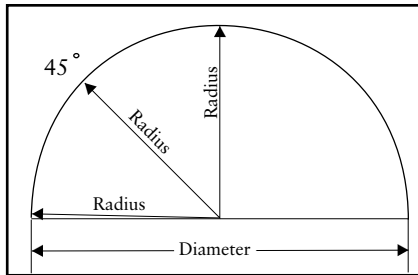

Figure B

Two-String Hanging Method

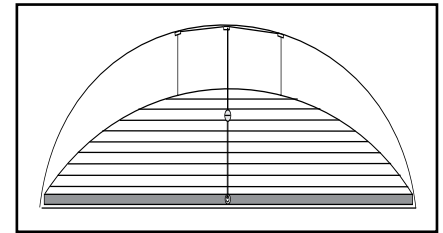

Figure C

Hardware Features | See Page 46 for Rail Dimensions

| | |
|--|---|
| Hardware colors for all Cellular fabrics | Color coordinated rails with white cord and silver tassel |
|--|---|

Upgrades

| | |
|---------------------------|---|
| Fabric Wrapped Upgrade | Fabric used is same fabric as the shade. Back of rail is white to outside. Color coordinated end caps. |
| Designer Metallic Upgrade | <ul style="list-style-type: none"> Oil Rubbed Bronze rails with bronze end caps, white cord and silver tassel. |

| Mounting Dimensions | Standard Cord Lock Rail | Deluxe Cord Lock Rail |
|---|--|-----------------------|
| Minimum Shallow Mount | 3/4" | 3/4" |
| Minimum Flush Inside Mount | 2" | 2 3/8" |
| Minimum Outside Mount | 3/4" | 3/4" |
| Minimum Side Mount | 1 1/8" | 1 3/8" |
| Minimum Flush Side Mount | 1 5/8" | 1 7/8" |
| Recommended Side Mounting Method | <ul style="list-style-type: none"> See page 47 figure B for recommended mounting method for side mount shades Width limit for side mount brackets is 48" | |

Finished Dimensions

| Inside and Side Mount | |
|----------------------------------|---|
| | <ul style="list-style-type: none"> Fabric will measure ordered width less: 3/8" Head rail* will measure ordered width less: 3/16" |
| Outside Mount | |
| | <ul style="list-style-type: none"> Fabric will measure ordered width Head rail* will measure ordered width plus: 3/16" |
| Exact (End Cap to End Cap) Mount | |
| | <ul style="list-style-type: none"> Fabric will measure ordered width less: 3/16" Head rail* will measure ordered width |

* Head rail measurements include endcaps.
Width and length measurements may vary +/- 1/8"

Applications

- Movable Arch

Ordering Information for Sunset Shades

- Specify IB or OB mount and rail color.
- Include a template if the shade is wider than 58".

Accessories

- 3' Expandable Pole (see pg 49)
- 5-10' Expandable Pole - Black



Specially designed pole end fits into the ball on Sunset Shades for easy operation.

Cellular Specialty Shades

SUNSET ARCHES HARDWARE SYSTEM

Sunset Features and Ordering Notes (Figure A)

- Sunset shades have horizontal pleats that stack at the bottom, on a stationary sill rail. Sunset shades are operated by a continuous cord that runs through a top mount guide block and back down through the stationary rail. A moving metal ball attached to the cord is used to raise and lower the shade. (See Figure E).
- **All Sunset arches which are not perfect half circles require a template if shade is wider than 58".** A perfect arch is twice as wide as it is high. See page 93 for template instructions.
- **All templates should be made from brown craft paper.** Comfortex offers template kits. Please contact Customer Service to order. Stock number: 751000
- Sunset shades which are not perfect half circles must have a height which is equal to or greater than 25% of the width.
- When ordering Sunset shades that are perfect half circles, make sure the radius of the arch remains constant to ensure a proper fit. (See Figure B) on page 71.
- **Size Limitations:** Though our maximum width is 84" and our maximum length is 72", there are limitations on some larger sizes due to excessive weight. If the Sunset width exceeds 66", the maximum length is 60". If the Sunset width exceeds 72", the maximum length is 48".
- **Stringing Method:** Depending on the curvature of a particular arch, it may be necessary to use the two string method to ensure proper fit and operation of your Sunset shade. Comfortex will determine the best stringing method after examination of the template.
- **For Symphony (All), Premiere 1/2" Fabrics, and Debut 1/2" single:** If Sunset shades exceed 65" in width or 50" in length, two pieces of mono filament cord are included to help stabilize the shade once installed.
- **For Debut 1/2" double, Debut 3/4" Fabrics and Linen Weave fabrics:** If Sunset shades exceed 45" in width or in length, two pieces of mono filament cord are included to help stabilize the shade once installed.
- **Arch Styles:** Sunset arches are available in a variety of styles including: palladium, eyebrow and bullet shaped arches. (See Figure D).

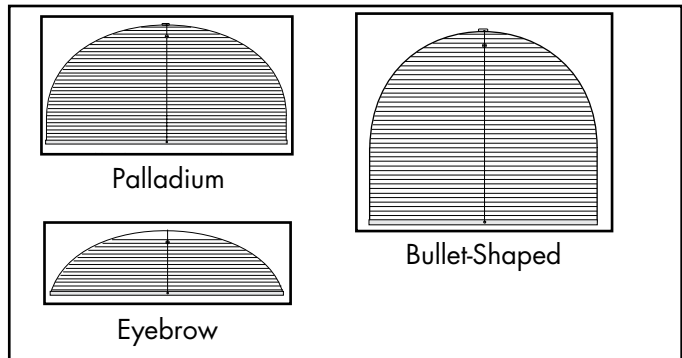

Figure D

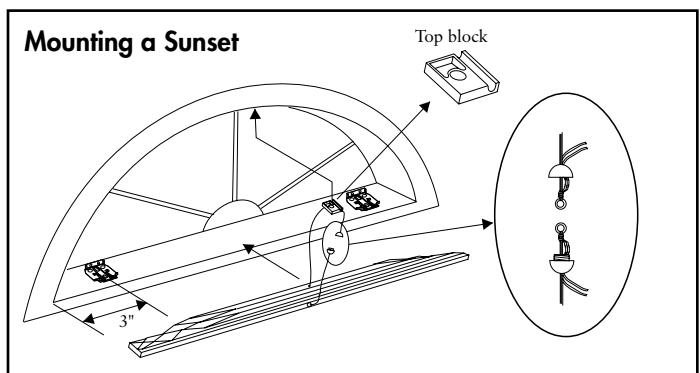

Figure E

Recommended Mounting Method for Side Mounting Shades

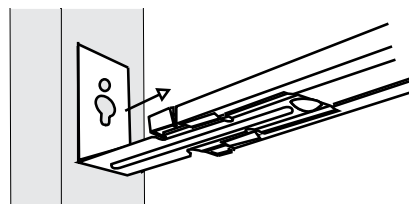

Figure F

Refer to the installation instructions on Comfortex.com/comfortex-dealers or the OnDemand Mobile Library for further details on side mounting shades.

Cellular Specialty Shades

QUARTER ROUNDS HARDWARE SYSTEM

Movable Quarter Round

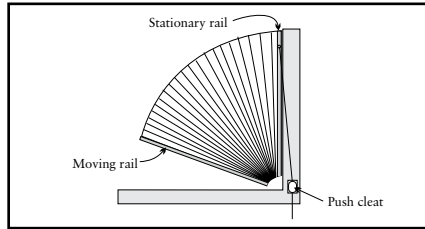

Figure A

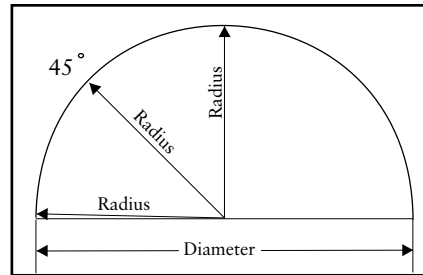

Figure B

Stationary Quarter Round

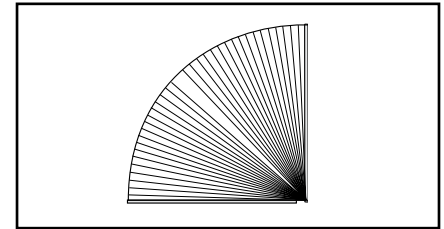

Figure C

Hardware Features | See Page 46 for Rail Dimensions

| | |
|--|--|
| Hardware colors for all Cellular fabrics | Color coordinated rails with white cord and tassel |
|--|--|

Upgrades

| | |
|---------------------------|--|
| Fabric Wrapped Upgrade | Fabric used is same fabric as the shade. Back of rail is white to outside. Color coordinated end caps. |
| Designer Metallic Upgrade | • Oil Rubbed Bronze rails and endcaps, bronze colored tassel and white cord. |

Mounting Dimensions

| | Standard Rail | Deluxe Rail |
|----------------------------|---------------|-------------|
| Minimum Shallow Mount | 3/4" | 3/4" |
| Minimum Flush Inside Mount | 2" | 2 3/8" |
| Minimum Outside Mount | 3/4" | 3/4" |
| Minimum Side Mount | 1 1/8" | 1 3/8" |
| Minimum Flush Side Mount | 1 5/8" | 1 7/8" |

Recommended Side Mounting Method

- See page 70 figure F for recommended mounting method for side mount shades

Finished Dimensions

Inside and Side Mount

- Fabric will measure ordered width less: 3/8"
- Head rail* will measure ordered width less: 3/16"

Outside Mount

- Fabric will measure ordered width
- Head rail* will measure ordered width plus: 3/16"

Exact (End Cap to End Cap) Mount

- Fabric will measure ordered width less: 3/16"
- Head rail* will measure ordered width

* Head rail measurements include endcaps. Width and length measurements may vary +/- 1/8"

Applications

- Stationary Fan Style Quarter Round
- Movable Fan Style Quarter Round

Accessories

- 5-10' Expandable Pole - Black



Specially designed pole end fits into the handle on movable Quarter Round Shades for easy operation.

Ordering Information for Quarter Rounds Shades

- Specify IB or OB mount and rail color.
- Include a template if the shade is a non-perfect quarter round.

Cellular Specialty Shades

QUARTER ROUNDS HARDWARE SYSTEM

Quarter Rounds Features (Figure A) pg 71

All Quarter Round Shades which are not perfect quarter circles require a template. Price according to the largest radius measurement.

- See page 93 for template instructions.
- **All templates should be made from brown craft paper.** Comfortex offers template kits. Please contact Customer Service to order. Stock number: 751000
- The horizontal (moving) rail of a Movable Quarter Round shade **must be smaller** than the vertical (stationary) rail to allow clearance for the moving rail. The shade will stack in the vertical position.
- When ordering arches as perfect quarter circles, make sure the radius of the arch remains constant to ensure a proper fit. (See Figure B) pg 71



Operation

Moveable Quarter Round

Pull the cord down to bring the shade to a stacked position.

The shade stacks against the vertical rail.

Push the button in on the cord cleat to release the cord and lower the shade across the window.

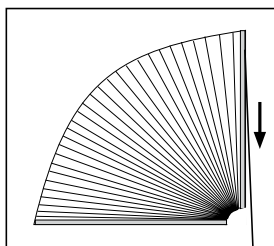

WARNING: To avoid possible strangulation, keep cords out of reach of children.

Cellular Specialty Shades

TRAPEZOIDS AND OCTAGONS HARDWARE SYSTEM

Movable Trapezoids

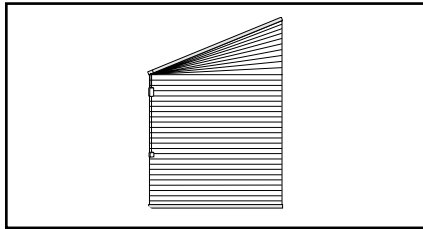

Movable Octagons

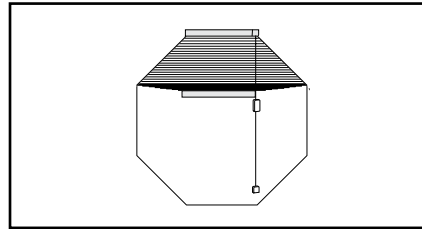

| | | |
|---|---|------------------------------|
| Hardware Features See Page 46 for Rail Dimensions | | |
| Hardware colors for all Cellular fabrics | Color coordinated head and bottom rails with white cord and tassel | |
| Upgrades | | |
| Fabric Wrapped Upgrade | Fabric used is same fabric as the shade. Back of rail is white to outside. Color coordinated end caps. | |
| Designer Metallic Upgrade | • Oil Rubbed Bronze head and bottom rails with bronze colored tassel, end caps and white cord. | |
| Mounting Dimensions | | |
| | Standard Cord Lock Rail | Deluxe Cord Lock Rail |
| Minimum Shallow Mount | 3/4" | 3/4" |
| Minimum Flush Inside Mount | 2" | 2 3/8" |
| Minimum Outside Mount | 3/4" | 3/4" |
| Minimum Side Mount | 1 1/8" | 1 3/8" |
| Minimum Flush Side Mount | 1 5/8" | 1 7/8" |
| Recommended Side Mounting Method | • See page 47 for recommended mounting method for side mount shades | |
| Finished Dimensions | | |
| Inside and Side Mount | | |
| | <ul style="list-style-type: none"> • Fabric will measure ordered width less: 3/8" • Head rail* will measure ordered width less: 3/16" | |
| Outside Mount | | |
| | <ul style="list-style-type: none"> • Fabric will measure ordered width • Head rail* will measure ordered width plus: 3/16" | |
| Exact (End Cap to End Cap) Mount | | |
| | <ul style="list-style-type: none"> • Fabric will measure ordered width less: 3/16" • Head rail* will measure ordered width | |
| * Head rail measurements include endcaps. Width and length measurements may vary +/- 1/8" | | |

Applications

- Movable Trapezoids
- Movable Octagons

Ordering Information for Trapezoid Shades

- Specify IB or OB mount and rail color.
- **Trapezoid orders must be faxed or emailed in with a diagram. Please provide measurements for all four sides when ordering. No template is required.**

Ordering Information for Octagon Shades

- Specify IB or OB mount and rail color.
- **Octagon Shades do not require a template. The width, length and one side are required measurements when ordering.**

Cellular Specialty Shades

TRAPEZOIDS AND OCTAGONS HARDWARE SYSTEM

Trapezoids (Figure A)

- **Trapezoid orders must be faxed in with a diagram. Please provide measurements for all four sides when ordering. No template is required.**
- The maximum slope of the top rail is 30 degrees from horizontal. Slope is the angle between slope and a horizontal line. The slope angle must be measured with a protractor.
- Sides of trapezoid must be parallel.
- Sill must be level for proper installation and operation of a trapezoid shade.
- Operating cord must be placed on the short side.
- See Figures B and C for trapezoid shade operation.

Octagons

- **Octagon Shades do not require a template.**
- **The width, length and one side are required measurements when ordering.**
- Octagon shades raise only to the point where the top angle begins. (See Figure D)
- See Figure F on page 70 for recommend mounting method for side mount shades.

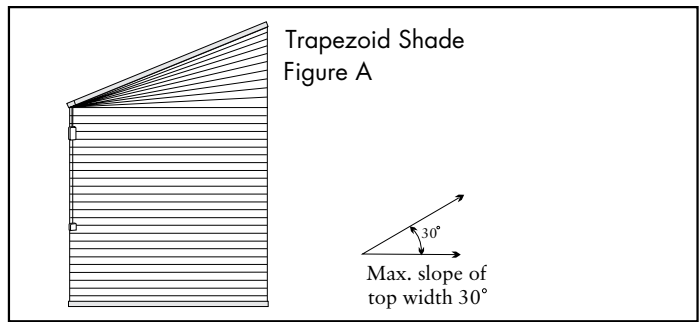

Trapezoid Shade Operation

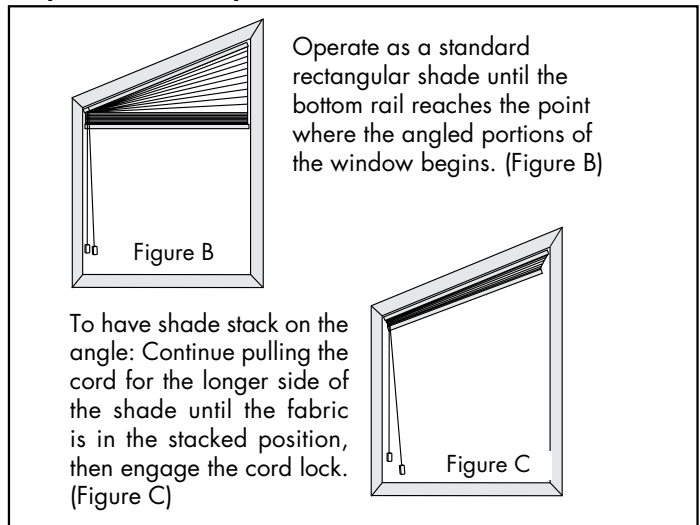

Octagon Operation

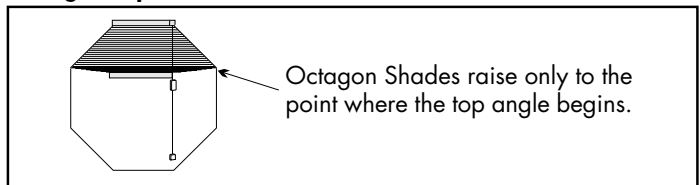
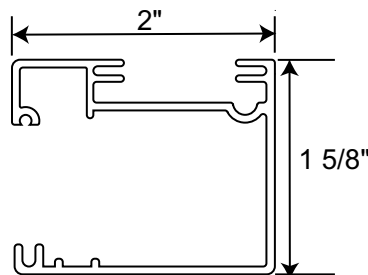

Figure D

Cellular Specialty Shades

SOPRANO SKYLIGHTS AND GREENHOUSE SHADES HARDWARE SYSTEM

**Soprano Rail Dimensions**

- Depth of rail: 2"
- Height of rail: 1 5/8"

| Hardware Features | | |
|---|--|-------------------|
| Hardware colors | <ul style="list-style-type: none"> • White head, bottom rail with white gear track retainer. • Bronze head, bottom rail with bronze gear track retainer. | |
| Mounting Dimensions | Soprano Skylights and Greenhouse Shades | |
| Minimum depth required for installation | 1 1/2" | |
| Minimum Flush Inside Mount (Rail Fully Recessed) | 2 3/8" | |
| Minimum Flush Inside Mount (Handle Fully Recessed) | 3" | |
| Deductions | | |
| | Total deduction on the bottom moving rail is 3/4" | |
| | Total deduction on the top rail is 1 1/2" | |
| Finished Dimensions | Symphony & Debut 1/2" | All Other Fabrics |
| Inside Mount | | |
| | <ul style="list-style-type: none"> • Fabric will measure ordered width less: 3/8" • Head rail* will measure ordered width less: 3/16" | 1 1/2" 1 5/16" |
| * Head rail measurements include endcaps. Width and length measurements may vary +/- 1/8" | | |

Applications

- Soprano Skylights
- Soprano Greenhouses

Soprano Shades are for inside mount applications only.

Ordering Information for Soprano Skylights and Greenhouse Shades

- Specify White or Bronze Rails.
- For Greenhouse Shades, supply measurements for: straight top section, curved section and vertical straight section when ordering.

Accessories

- Two Moving Rails*
- 5-10' Expandable Pole - Black

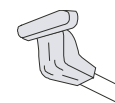

Specially designed pole end fits into the handle of Soprano shades for easy operation at any angle.

*This option allows you to move shade up from the bottom or down from the top. For ultimate control of light and privacy. See page 83 for upgrade pricing.

Skylight Installation Angles

- For inside mount applications on straight (planar) runs.
- Minimum Installation angle of 5 degrees.
- Maximum installation angle of 85 degrees.
- Horizontal (0 degrees) and vertical (90 degrees) applications are not recommended.

Cellular Specialty Shades

SOPRANO SKYLIGHTS AND GREENHOUSE SHADES HARDWARE SYSTEM

Soprano Skylight Features (Figure A)

- Soprano Shades feature a polycarbonate track system. The hidden gear track allows for smooth operation of the shade and controls light.
- The gear track retainer is White or Bronze to match the moving bottom rail. **Please specify rail color when ordering.**

Soprano Greenhouse Shades Features (Figure B)

- See Figure C below for Greenhouse shade ordering information.
- Soprano Shades are for inside mount applications only.
- **All greenhouse orders require a completed and signed greenhouse shade order form.** Orders must be mailed or faxed to Comfortex for processing. Download a copy at www.comfortex.com/comfortex-dealers or from the OnDemand Library Mobile Library.
- Soprano Shades feature a polycarbonate track system. The hidden gear track allows for smooth operation of the shade and controls light.
- The gear track retainer is White or Bronze to match the moving bottom rail. **Please specify rail color when ordering.**

Soprano Skylights

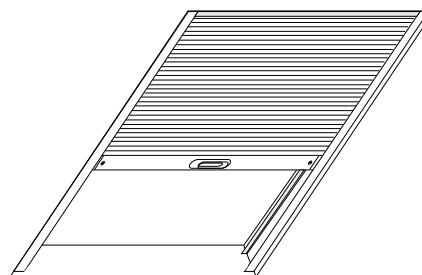

Figure A

Soprano Greenhouses

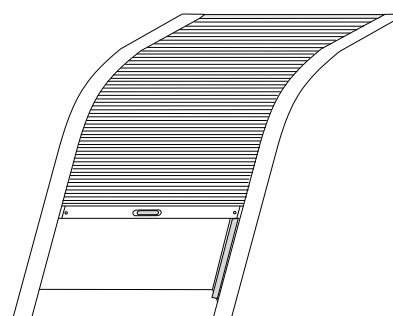
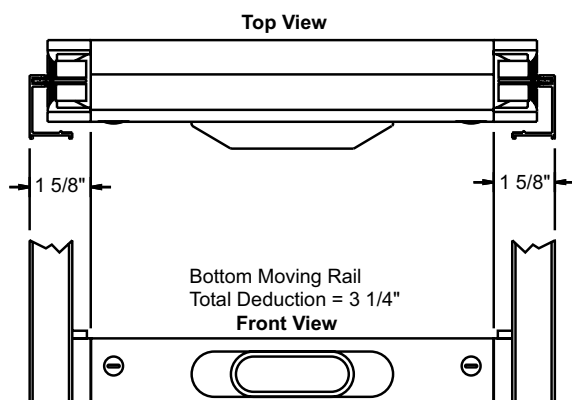
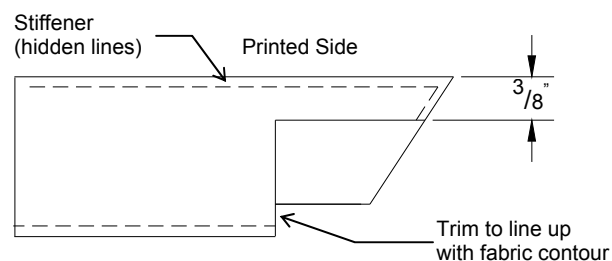

Figure B

Soprano Skylights and Greenhouses Moving Rail
Top and Front View

Soprano Fabric Notch for small pleat fabric

Additional trimming for bottom stiffener
(and attached single layer of fabric).

Greenhouse Ordering Information Figure C

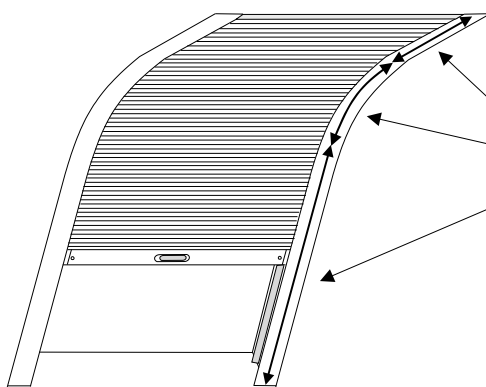

The side rails for greenhouse shades are notched at the curve in the factory. Please supply measurements for:
Straight top section,
Curved section and
Vertical straight section when ordering.

Cellular Specialty Shades

BALCONY SHADING HARDWARE SYSTEM

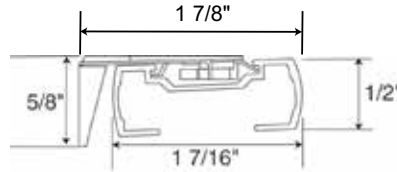
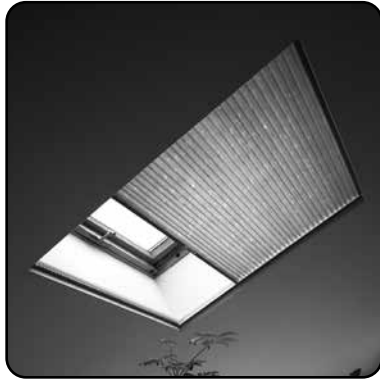

Balcony Rail Dimensions

- Depth of rail: 1 7/16"
- Depth of rail and bracket: 1 7/8"
- Height of rail: 1/2"

| Hardware Features | |
|---|---|
| Hardware colors for all fabrics | Color coordinated head and bottom rails with white cord in a white sidetrack. |
| Upgrades | |
| Fabric Wrapped Upgrade | Fabric wrapped head and bottom rails. Fabric used is same fabric as the shade. Back of rail is white to outside. |
| Designer Metallic Upgrade | <ul style="list-style-type: none"> • Designer Oil Rubbed Bronze head and bottom rails with white cord in a white sidetrack. • Designer Brushed Nickel head and bottom rails with white cord in a white sidetrack. |
| Mounting Dimensions - Inside Only | |
| Balcony Shading System | |
| Minimum required for installation | 1 1/4" |
| Minimum Flush Inside Mount (Rail Fully Recessed) | 2 1/4" |
| Minimum Flush Inside Mount (Handle Fully Recessed) | 2 1/16" |
| The widest width of the window cannot exceed the narrowest width of the window by more than 3/8". | |
| Finished Dimensions | |
| Inside Mount | |
| | <ul style="list-style-type: none"> • Fabric will measure ordered width less: 1" • Head rail* will measure ordered width less: 3/16" |
| * Head rail measurements include endcaps. Width and length measurements may vary +/- 1/8" | |

Applications

- Horizontal, Angled and Vertical rectangular windows and skylights. Balcony Shading Systems are for inside mount applications only.

Ordering Information for Balcony Shading System

- Specify rail color.
- Specify when ordering: Application angle: Angled, Horizontal or Vertical.

Accessories

- 3' Expandable Pole - Silver (see pg 26)
- 5-10' Expandable Pole - Black



Specially designed pole end fits into the handle of Balcony shades for easy operation at any angle.

Cellular Specialty Shades

BALCONY SHADING HARDWARE SYSTEM

Balcony Shading System Features

- Balcony Shades work in three orientations applications: Angled, Horizontal and Vertical.
Horizontal works on slope angles 0 to 15 degrees.
Angled works on slope angles 15 to 75 degrees.
Vertical works on slope angles 75 to 90 degrees.
- Balcony shades can be mounted on their side. (See Figure A). Use the vertical measurement as your width (max. 36") and the horizontal measurement as your length (max. 48").
- Polycarbonate track system provides superior insulation and light blocking. The enclosed sides provide full privacy.
- No exposed cords, eliminates risk of injury to children.

Balcony Vertical Applications

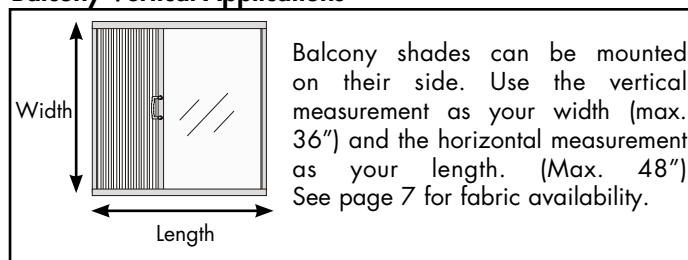

Figure A

Maximum Shade Area

Maximum shade areas (in square feet) varies with slope and fabric type.

| | Horizontal | Angled | Vertical |
|-----------------------------|------------|--------|----------|
| Symphony (All) | 24 | 24 | 18 |
| Debut Light Filtering (All) | 24 | 24 | 18 |
| Virtuoso (All) | 24 | 24 | 18 |



Cellular Specialty Shades

7.4V MEZZO RECHARGEABLE MOTORIZED SKYLIGHT HARDWARE SYSTEM

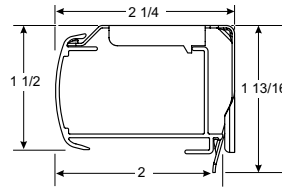

Simplicity Motorized Rail Dimensions

- Depth of rail: 2"
- Depth of rail and bracket: 2 1/4"
- Height of rail: 1 1/2"
- Height of bracket: 1 13/16"

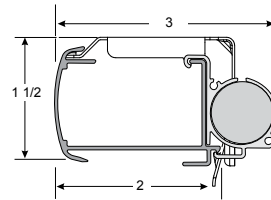

Simplicity Motorized Rail with External Battery Dimensions (shades under 20")

- Depth of rail: 2"
- Depth of rail, bracket & battery: 3"
- Height of rail: 1 1/2"
- Height of bracket: 1 13/16"

Mezzo Motorized Skylight Shades are designed for fabric to stack at the top only.

| Hardware Features | |
|---|---|
| Hardware colors | White head, bottom and side rails |
| Simplicity Remotes | Upper and lower limit stops pre-programmed, Intermediate stop "favorites" position can be programmed on-site, 14 Channel remote options |
| Mounting Dimensions | |
| | Mezzo Motorized Skylight Shades |
| Minimum Flush Inside Mount | 2 1/2" |
| | <ul style="list-style-type: none"> • Should not be more than 1/2" out of square to perform as intended • The widest width of the window cannot exceed the narrowest width of the window by more than 3/8". • The shade must be mounted with the fabric stack at the top of the window |
| | See page 80 for Solar Panel Mounting information. |
| Finished Dimensions | |
| Inside Mount | |
| | <ul style="list-style-type: none"> • Fabric will measure ordered width less: 1 1/4" • Head rail* will measure ordered width less: 3/16" |
| * Head rail measurements include endcaps. Width and length measurements may vary +/- 1/8" | |
| MOTORIZATION - HARDWARE UPGRADE SURCHARGES AND ACCESSORIES All standard discounts apply to motorized shades | |
| | ADD |
| Simplicity - Motor and Battery Wand | \$300 |
| Simplicity 14 Channel White Remote | \$50 |
| 48" Extension Wire: | \$10 |
| Simplicity Smart Controller (NEO) | \$280 |
| 7.4v Solar Panel & Mounting Brackets | \$120 |

Front Access Control

All Mezzo Shades with Rechargeable Simplicity motors come with a front-facing, flip-top cover for convenient access to the charging port, reset button, and on/off switch.

More information and pictures on page 81.

Ordering Information for Mezzo Motorized Skylight Shades

- Specify inside mount dimensions.
- Specify fabric color and style.
- Specify remote and other accessories if needed.

Cellular Specialty Shades

7.4V MEZZO RECHARGEABLE MOTORIZED SKYLIGHT HARDWARE SYSTEM _____

Applications

- Angled and Vertical motorized skylight shades.
- Mezzo Motorized Skylight Shades are for inside mount applications only.
- Skylights with Simplicity motorization will not operate properly if installed in a completely horizontal application. The minimum recommended slope is 5 degrees.
- Must be mounted with fabric stack at top.

RECHARGEABLE SIMPLICITY MOTORS

The Simplicity Motor program features a battery powered motor utilizing a rechargeable battery hidden inside the shade head rail. Simplicity motors are compact and use a radio frequency remote to raise or lower the shades.

Simplicity Rechargeable Battery

The rechargeable battery is concealed in the head rail of the shade. A charger is required for the rechargeable battery. The rechargeable battery comes fully charged from the factory.

Shades with width of 18"- 20" require the battery wand to be mounted externally.



Charging Port on Back of Head rail.

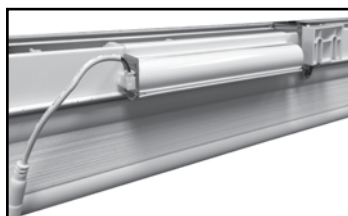

Snap-On external battery for Mezzo shades under 20" in width.

Top Down-Bottom Up Simplicity Motor Hand Held 14 Channel Remote

The TDBU remote has 14-channels. Each channel has a setting able to operate the middle rail and a setting able to operate the bottom rail. The TDBU remote is required for TDBU motors, but can be used with other motors as well. The **14 Channel TDBU remote** can operate up to fourteen shades individually or 14 groups. Simplicity Rechargeable Motorized Cellular Shades are programmed at the factory with the "up and down" limits. The shades are **UNLINKED** from the remote so they are not able to operate during shipping. Each shade should be installed **after** linking it to the remote.



Simplicity TDBU remotes and holders are white in color. The remote comes with a holder which can be mounted to a wall for easy storage. The range of the remote is approximately 80 feet. A **14 Channel (14C) remote** can be utilized on all Simplicity motorized shades.

Solar Panel Recharge Option

Plugs in to any Simplicity Rechargeable Remote control shade (does not work with PowerTouch)

Provides constant trickle charge to 7.4v Li-Ion Rechargeable battery packs. Will prolong the life of the charge of the 7.4v rechargeable battery packs, and in some applications will maintain charge indefinitely.

Life of charge is subject to application variables such as, size and weight of shade, frequency of use, amount of direct sunlight exposure, etc.

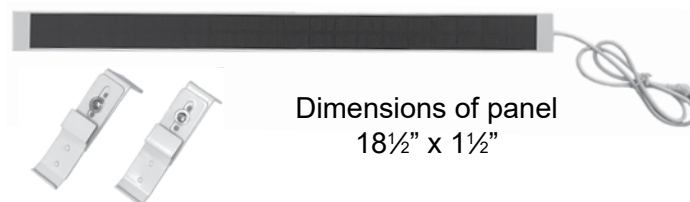

Dimensions of panel
18½" x 1½"

- Solar Panel with Mounting Brackets: \$120.00

Solar Recharge Optimum Application

- Full direct sunlight (minimum 2 hours per day) to maintain full charge. Based on one operation cycle per day (one open, one close).
- Excessive duration of cloudy weather will impact the rate of charge.
- Avoid any obstructions including mullions and screens.

Solar Panel Mounting

Bottom portion of the bracket may be lowered if needed for more sun exposure. Bracket can be mounted behind or next to shade mounting bracket.

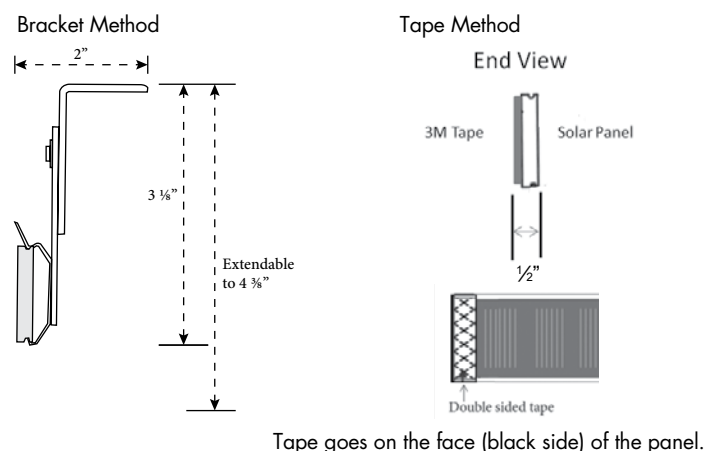

If the solar panel is mounted directly behind the headrail at the top of the window, you need to make sure that the solar panel does not interfere with the shade mounting brackets also. The solar panel can go between brackets spaced apart, or behind brackets if the depth of the window casing allows.

Cellular Specialty Shades

7.4V MEZZO RECHARGEABLE MOTORIZED SKYLIGHT HARDWARE SYSTEM _____

**Battery Charger**

8.4 Volt charger requires a standard power outlet to recharge the battery. You must specify charger when ordering a Simplicity Rechargeable Shade. The charger plugs into the charger port. The charger is black and comes with a 156" wire. The dimensions are 1" wide x 2½" length x 1¾" deep.

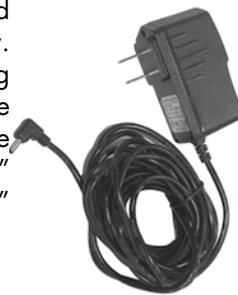
**Important Simplicity Motorized Shades Operating and Installation Information**

- Simplicity Motorized Shades installed into windows with metal casings may have a reduced radio frequency range, or may not operate at all, depending on the application.
- Do not let the antenna on the motor touch any metal objects. This may interfere with signals from the remote control.

Front Access Control

All Mezzo Shades with Rechargeable Simplicity motors come with a front-facing, flip-top cover for convenient access to the charging port, reset button, and on/off switch.

Shades with front control access include an auxiliary charging port in the back. This port is ideal for a solar panel charging kit or for shades where a top treatment may limit access to the front-side port.

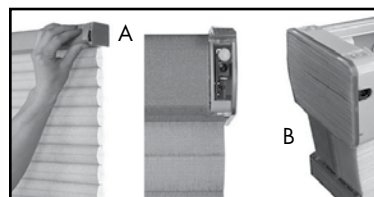

A) Front Control

B) Back of Head rail.

Cellular Specialty Shades

FRENCH DOOR DÉCOR HARDWARE SYSTEM



Standard Head Rail

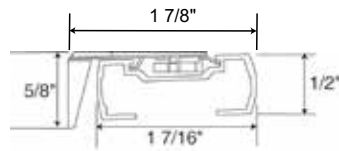

Deluxe Head Rail

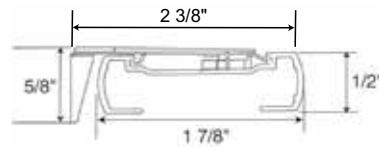

Standard Rail

- Depth of rail: 1 7/16"
- Depth of rail and bracket: 1 7/8"
- Height of rail: 1/2"
- Height of bracket: 5/8"

Deluxe Rail

- Depth of rail: 1 7/8"
- Depth of rail and bracket: 2 3/8"
- Height: 1/2"
- Height of bracket: 5/8"

| Hardware Features | |
|---------------------------|--|
| Hardware colors | Color coordinated head, middle, bottom rails and end caps |
| Upgrades | |
| Fabric Wrapped Upgrade | Fabric used is same fabric as the shade. Back of rail is white to outside. Color coordinated end caps |
| Designer Metallic Upgrade | <ul style="list-style-type: none"> • Oil Rubbed Bronze head, middle, bottom rails and end caps. |

| Mounting Dimensions | Standard Rail | Deluxe Rail |
|--|----------------------|--------------------|
| Minimum Shallow Mount | 3/4" | 3/4" |
| Minimum Flush Inside Mount | 2" | 2 1/2" |
| Minimum Flush Inside Mount (Handle Fully Recessed) | 2 9/16" | 3" |
| Minimum Outside Mount | 3/4" | 3/4" |
| Minimum Side Mount | 1 1/8" | 1 3/8" |

The widest width of the window cannot exceed the narrowest width of the window by more than 3/8".

| | |
|---|---|
| Recommended Side Mounting Method | <ul style="list-style-type: none"> • See page 47 for recommended mounting method for side mount shades • Width limit for side mount brackets is 48" |
|---|---|

Finished Dimensions

| Inside and Side Mount | |
|---|---|
| | <ul style="list-style-type: none"> • Fabric will measure ordered width less: 3/8" • Head rail* will measure ordered width less: 3/16" |
| Outside Mount | |
| | <ul style="list-style-type: none"> • Fabric will measure ordered width • Head rail* will measure ordered width plus: 3/16" |
| Exact (End Cap to End Cap) Mount | |
| | <ul style="list-style-type: none"> • Fabric will measure ordered width less: 3/16" • Head rail* will measure ordered width |

* Head rail measurements include endcaps. Width and length measurements may vary +/- 1/8"

Cellular Specialty Shades

FRENCH DOOR DÉCOR HARDWARE SYSTEM

Applications

- Stationary Door Décor
- Movable Door Décor
- Top Down - Bottom Up Door Décor
- Cover french doors, transoms, and side lights.

French Door Décor Hardware Features

- Features two non-moving rails which are mounted in the window or door. A tension control system enables the movable rail to be easily moved with the touch of a finger. The only visible cords are the ones that hold the movable middle rail in place.
- The widest width of the window cannot exceed the narrowest width of the window by more than $\frac{3}{8}$ ".

Stationary Non-Movable French Door Décor Shades

- Top and bottom rails are mounted to the window and are stationary.

Movable French Door Décor Shades

- Top and bottom rails are mounted to the window, one middle movable rail raises from the bottom.

Top Down - Bottom Up Option

- Top and bottom rails are mounted to the window, two movable rails allow the shade to lower from the top and raise from the bottom.
- The non-movable top and bottom rails are attached to the window or door.
- Ideal for entry ways with narrow windows next to doors and other narrow windows that are easily accessible.

Ordering Information for French Door Décor

- Specify IB or OB mount and rail color.
- Specify stationary, movable or Top Down - Bottom Up.

French Door Decor Cellular Shades Hardware

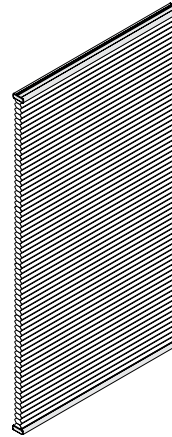

Stationary Non-Movable

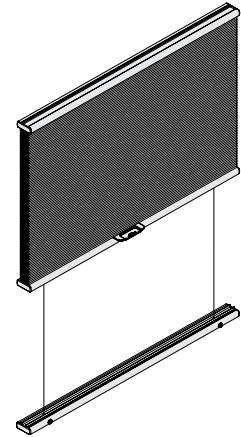

Shown open with movable rail option

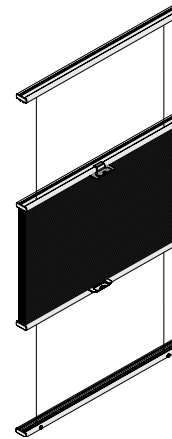

Shown open with Top Down - Bottom Up Option

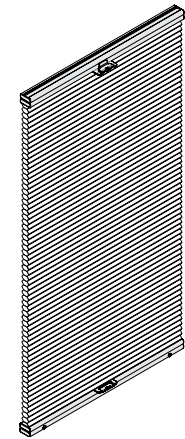

Shown closed with Top Down - Bottom Up Option

Cellular Specialty Shades

DAY-NIGHT SHADES HARDWARE SYSTEM



Standard Cord Lock Rail

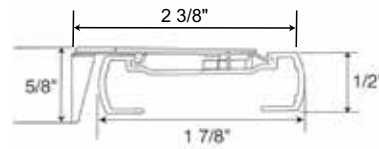
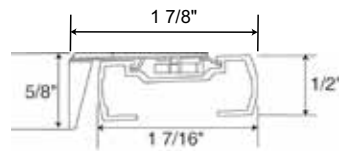

Standard Cord Lock Rail

- Depth of rail: 1 7/16"
- Depth of rail and bracket: 1 7/8"
- Height of rail: 1/2"
- Height of bracket: 5/8"

Deluxe Cord Lock Rail

- Depth of rail: 1 7/8"
- Depth of rail and bracket: 2 3/8"
- Height: 1/2"
- Height of bracket: 5/8"

| Hardware Features | | |
|--|---|--------------------|
| Hardware colors for all Cellular fabrics | Color coordinated head, middle and bottom rails with white cord and tassel. See additional details on page 85. | |
| Upgrades | | |
| Fabric Wrapped Upgrade | Fabric used is same fabric as the shade. Back of rail is white to outside. Color coordinated end caps. | |
| Designer Metallic Upgrade | • Oil Rubbed Bronze head and bottom rails with bronze colored tassel, end caps and white cord. | |
| Mounting Dimensions | | |
| | Standard Rail | Deluxe Rail |
| Minimum Shallow Mount | 3/4" | 3/4" |
| Minimum Flush Inside Mount | 2" | 2 3/8" |
| Minimum Outside Mount | 3/4" | 3/4" |
| Minimum Side Mount | 1 1/8" | 1 3/8" |
| Recommended Side Mounting Method | <ul style="list-style-type: none"> • See page 47 for recommended mounting method for side mount shades • Width limit for side mount brackets is 48" | |
| Finished Dimensions | | |
| Inside and Side Mount | | |
| | <ul style="list-style-type: none"> • Fabric will measure ordered width less: 3/8" • Head rail* will measure ordered width less: 3/16" | |
| Outside Mount | | |
| | <ul style="list-style-type: none"> • Fabric will measure ordered width • Head rail* will measure ordered width plus: 3/16" | |
| Exact (End Cap to End Cap) Mount | | |
| | <ul style="list-style-type: none"> • Fabric will measure ordered width less: 3/16" • Head rail* will measure ordered width | |
| * Head rail measurements include endcaps. Width and length measurements may vary +/- 1/8" | | |

Applications

- Standard Rectangular with cellular fabrics only.

Day - Night Shade Specifications

Refer to the appropriate fabric sections for proper pricing.

Fabrics

- Some fabrics (i.e. Symphony Blackout) can be used exclusively only as a bottom panel only.

Cellular Specialty Shades

DAY-NIGHT SHADES HARDWARE SYSTEM

Rail Colors and Cord Colors

- **Color Coordinated Rail Shades:** The top rail and middle rail will coordinate with top fabric and bottom rail will coordinate with the bottom fabric. The cord and tassel will be white. Not available with Color Lux Shades.
- **Designer Metallic Hardware Shades:** All rails, end caps and tassels will be the selected metallic color. Cords will be white.
- **Fabric Wrapped Rail Shades:** The top rail and middle rail will coordinate with top fabric and bottom rail will coordinate with the bottom fabric. The cord and tassel will be white. End caps and cord lock will be color coordinated.

Ordering Information for Day - Night Shade

- Specify fabrics, top and bottom panels.
- Specify IB or OB mount and rail color.

TOP FABRIC

| CELLULAR | Width | | Length | |
|---|-------|-----|--------|-----|
| | Min | Max | Min | Max |
| Verona | 12" | 72" | 18" | 96" |
| Boutique | 12" | 72" | 18" | 96" |
| Debut 1/2" Double Cell Light Filtering | 12" | 72" | 18" | 96" |
| Debut 1/2" Single Cell Light Filtering | 12" | 72" | 18" | 96" |
| Debut 3/4" Single Cell Light Filtering | 12" | 72" | 18" | 96" |
| Linen Weave Light Filtering* | 12" | 72" | 18" | 96" |
| Linen Weave Room Darkening* | NA | NA | NA | NA |
| Premiere 1/2" Single Cell Blackout | NA | NA | NA | NA |
| Premiere 1/2" Single Cell Light Filtering | 12" | 72" | 18" | 96" |
| Premiere 3/4" Single Cell Blackout | NA | NA | NA | NA |
| Premiere 3/4" Single Cell Light Filtering | 12" | 72" | 18" | 96" |
| Aspen 3/8" Double Cell Light Filtering | 12" | 72" | 18" | 96" |
| Symphony 3/8" Double Cell Blackout | NA | NA | NA | NA |
| Symphony 3/8" Double Cell Light Filtering | 12" | 72" | 18" | 96" |

BOTTOM FABRIC

| Width | | Length | |
|-------|-----|--------|-----|
| Min | Max | Min | Max |
| 12" | 72" | 18" | 96" |
| 12" | 72" | 18" | 96" |
| 12" | 72" | 18" | 96" |
| 12" | 72" | 18" | 96" |
| 12" | 72" | 18" | 96" |
| 12" | 72" | 18" | 96" |
| 12" | 72" | 18" | 96" |
| 12" | 72" | 18" | 96" |
| 12" | 72" | 18" | 96" |
| 12" | 72" | 18" | 96" |
| 12" | 72" | 18" | 96" |
| 12" | 72" | 18" | 96" |
| 12" | 72" | 18" | 96" |
| 12" | 72" | 18" | 96" |

* Day-Night Shades can only be built in conjunction with other 3/4" cellular fabrics. All Debut includes print patterns: Strie, Terazzo, Angel Hair, Strat, Florance, Blossom, Country Woven and Homespun.

COMFOTEX CUSTOM GRAPHIC SHADES



Comfortex
WINDOW FASHIONS

Custom Graphic Shades

CELLULAR SHADE FEATURES & GENERAL INFORMATION

Custom Graphics

With Custom Graphics, you can print anything on a Cellular Shade. From logos to personal photos, theme room graphics or advertising for your storefront, anything you envision can be featured on a Custom Graphics Cellular Shade.

Hardware | Mounting | Finished Dimensions

[See Page 45](#)

Available Fabrics

Custom Graphics are available with the following fabrics:

- Premiere ½" and ¾" Light Filtering Fabrics
- Premiere ½" and ¾" Blackout Fabrics

Custom Graphics can work for any window.

Advertising and Store Identification

Contact local businesses and explain how you can turn their window space into advertising!



Decorative and Personal Photos

Customers can now convert their special photos into a highly personalized room!

Printing Information and Options

Custom Graphics will look different from fabric to fabric. The color vibrancy on cellular shades will be muted due to the density of the fabrics and the printing process.

To view examples on Cellular Shades, visit the Custom Graphic section of the Comfortex website.

Single Sided Printing:

Cellular Custom Graphics are available as single-sided only. Double-sided graphics are not available.

You can choose to have Side A face the room side or the street side.



Side A
Shows Printed Image



Side B
White Fabric

Ordering Information for Custom Graphics Cellular Shades

Step 1. Fill out the Custom Graphics Cellular Shades

Order Form. This form includes your fabric and hardware selections. Fax the completed order form to (800) 336-4580 to place your order.

Custom Graphic orders can only be placed by faxing this form.

Step 2. Receive your Comfortex Work Order Confirmation number. Be sure to reference this number when submitting you artwork in Step 3.

Step 3. Send your graphic files via email to:
CustomGraphics@Comfortex.com

Or ship a CD containing your graphics to:
Custom Graphics
Comfortex Window Fashions
21 Elm Street
Maplewood, NY 12189

Graphic File Specifications

Preferred Formats:

- Adobe Illustrator
- EPS

Other Accepted Formats:

- TIFF
- JPEG
- PSD

- All typography should be converted to paths when submitting an Illustrator or EPS file.
- TIFF and JPEG files should be submitted at the largest size possible, 300 DPI is preferred. We will size your graphics according to your shade size and specifications.
- Contact Comfortex Customer Care at 800-843-4151 with all questions regarding Custom Graphic Orders.
- Comfortex will not print any copyrighted custom graphics without appropriate permission.

Step 4. The Custom Graphic Team will email a PDF proof of your shade order for you to approve. Once the artwork is approved, it will take two weeks for your order to be printed, assembled, and shipped.

Custom Graphic Shades

CELLULAR SHADE FEATURES & GENERAL INFORMATION

How to order Custom Graphic Shades

STEP 1. FAX OR E-MAIL YOUR ORDER

Fax the appropriate Custom Graphics Cellular order form located on comfortex.com/comfortex-dealers to (800) 336-4580. Or e-mail the order form to customercare@comfortex.com. Upon receipt and review of your order, you will receive a work order confirmation number from Comfortex. Please be sure to reference this number when submitting your artwork in Step 2.

STEP 2. SOURCE AND SEND YOUR GRAPHIC

Source your graphic from a stock photo site such as www.istockphoto.com or use your own high resolution photography. Send your files via e-mail to: customgraphics@comfortex.com OR ship a CD/portable media containing your graphics to:

Custom Graphics
 Comfortex Window Fashions
 21 Elm Street
 Maplewood, New York 12189

Using Online Stock Agencies for Graphics for Your Shades

Sometimes, finding the right graphic or photograph to fit your shade size, shape, or content can be challenging. Fortunately, many web sites offer a great solution. Online stock agencies allow you to purchase reasonably priced, royalty-free digital illustrations, graphics, photographs, patterns, and more in thousands of different subject areas. Some of the more popular sites include:

- thinkstock.com
- istockphoto.com
- veer.com
- shutterstock.com
- gettyimages.com
- 123rf.com
- photosearch.com

Using these sites is easy, simply follow these steps:

Step 1. Create an account and search for your image (i.e. apples).

Step 2. Select, purchase, and download the image you like. You may be given a choice of sizes, so take care to select an option large enough for your needs.

Be sure to include the Work Order Confirmation Number received from Comfortex Customer Service with your graphic files.

STEP 3. APPROVE YOUR PROOF

The Custom Graphic Team will email a PDF proof of your shade order which must be reviewed and approved for production to begin. Once the artwork is approved, it will take 2 weeks for your order to be printed, assembled, and shipped.

Graphic File Specifications

Preferred Formats

- Vector files/Adobe Illustrator (AI or EPS)
Please convert all typography to paths prior to submitting your vector artwork.
- TIFF, JPG/JPEG, or Adobe Photoshop (PSD) files with a minimum resolution of 100 pixels per inch at 100% size. For example, a shade measuring 30" x 40" should be supported by a graphic measuring at least 3000 x 4000 pixels.
- Adobe Acrobat (PDF) files created in "Press Quality" or "High Quality Print" with a minimum resolution for all raster elements of 100 pixels per inch at 100% size.

Graphics optimized for, or harvested from the internet are, in general, not suitable for reproduction onto shades.

Comfortex will seek to verify ownership and rights to reprint for all images showcasing copyrighted material.

Questions? Please contact Comfortex Customer Care with all questions regarding Custom Graphic Orders.



EZ Level



Making A Template



Measuring



Child Safety



Cleaning & Care



Cellular Shade Collection

GENERAL INFORMATION

Scotchgard™ and Certified Fabrics

Scotchgard Protection

Scotchgard™ Protector is available with all cellular Shades. Scotchgard™ keeps your shades looking newer, fresher and cleaner longer.



A combination of the latest advances in stain release and repellency provides exceptional stain protection. Spills wipe away easily and most dirt and stains lift out when cleaned. Both sides of the fabric are treated with Scotchgard.

GREENGUARD Certified Fabrics

GREENGUARD Indoor Air Quality Certified® Fabrics
The GREENGUARD Environmental Institute has established performance based standards to define goods with low chemical and particle emissions for use indoors.

The following fabrics have the passed GREENGUARD Indoor Air Quality Certified® certification program for low emitting interior building materials, furnishings, and finish systems:

- Symphony (All)
- Virtuoso (All)
- Baritone (All)
- Premiere (All)
- Natural Linen Flax
- Debut (All)
- Linen Weave

The following fabrics have the passed GREENGUARD Children & SchoolsSM product certification program for low emitting interior building materials, furnishings, and finish systems used in educational (day care and K-12) environments:

- Symphony Light Filtering
- Symphony Blackout

Symphony Flame Resistant Fabrics

Symphony Flame Resistant Fabrics have been registered as a Flame Resistant Products by the California State Fire Marshall for products identified in section 13115, California Health and Safety Code (California CHSC). Copies of the certificates are located on the Comfortex.com/comfortex-dealers web site or on the On Demand Mobile library.

Color Selection

Use the current Cellular Shades Collection sample book to select colors from the Symphony light filtering fabric collection. All thirty colors are available in 3/8" Symphony light filtering double cell and 3/4" light filtering single cell.

Ordering Flame Resistant Shades

The SKU structure for Symphony Flame Resistant material is: 3012 05 XXX (XXX representing the color number).

To order Symphony Flame Resistant Shades: Use the SKU number listed on the decks.

The SKU structure for the 3/4" Symphony Flame Resistant material is: 2512 05 XXX

To order 3/4" Symphony Flame Resistant Shades:

Use the Symphony three digit color number to identify your desired color.

In this example:
2512 05 108



EZ Level on Comfortex Cellular Shades

EZ Level makes quick work of leveling without cords to cut or tuck into a rail. No special tools needed – just use a nickel, quarter or penny to adjust plug on the bottom rail.

EZ Level is standard on all Cellular and Pleated Shades with the following hardware systems:

- Standard and Deluxe Cord Lock
- Cordless Ultra
- Cord Loop
- SlumberShades
- Simplicity Motorized Systems

EZ Level is not available with Lift & Lock Cordless.

How does EZ Level work?

- Slightly raise the bottom rail you want to level.
- Insert a coin or flat head screwdriver into the adjustment screw and turn it.
- Turn the adjustment screw clockwise or counter clockwise to make slight adjustments up or down.



- One quarter turn of the adjustment screw will move the bottom rail up or down 1/4".
- Lower the rail to check the level and make further adjustments if necessary.

Cellular Shade Collection

GENERAL INFORMATION

Cleaning and Care

While beautiful and pleasing to the eye, all Comfortex products are designed to be durable, easily cared for and easily cleaned. Our non-woven fabrics are inherently anti-static and repel dust, but occasional feather dusting or vacuuming may be necessary to keep the fabrics clean and bright. Comfortex Cellular fabrics may be ultrasonically cleaned.

Cleaning Symphony Blackout Fabrics: Our blackout fabrics are inherently anti-static and repel dust, but occasional cleaning may be necessary to keep the fabrics clean and bright. The fabric can be dusted with a soft, clean cloth, feather duster or lightly vacuumed with a soft brush attachment. To spot clean, use a cloth or sponge dipped in a light solution of lukewarm water and clear dish detergent and lightly dab. Do not scrub the surface. Rinse thoroughly.

Cleaning all other Comfortex Cellular Fabrics:

Our light filtering and room darkening fabrics are inherently anti-static and repel dust, but occasional cleaning may be necessary to keep the fabrics clean and bright. The fabric can be dusted with a soft, clean cloth, feather duster or lightly vacuumed with a soft brush attachment. Spills and stains can be lightly blotted with a cloth or damp sponge. More difficult stains may require soaking in water with mild soap. For this, remove the shades from the window and soak in warm water. Complete immersion of hardware is not recommended.

DO NOT submerge the Cordless Ultra head rail in water. When damp, lay flat to dry or place back in window and raise tightly to recrisp pleats. Please test any stronger cleaners on an unobtrusive portion of the shade before using.

For additional advice on care or cleaning, please contact our Technical Services Department.

Scotchgard™ Treated Shades

The following are the recommended cleaning and care instructions for window treatments with fabric treated with Scotchgard™ Protector.

- Gently blot liquid stains immediately with a clean, white cloth.
- If stain remains, prepare a solution of ¼ teaspoon of clear, non-bleaching dish detergent mixed with 1 cup of lukewarm water. Dampen a clean white cloth and gently blot the stain.
- Do not overwet the fabric or excessively rub the stained area.
- See the Installation and Care instructions for complete details.

For additional assistance with stain removal, call the Scotchgard™ Protector Service Center at 1-800-433-3296. Customer Care representatives are available Monday through Friday, 8am to 6pm CT.

Cut-Outs

Cut-outs are available with all cellular fabrics and are subject to approval by the Comfortex Technical Service department.

There are no limits on cut out lengths. There are limits on cut out widths:

Cellular shade widths 18" or less 3" maximum width
Cellular shade widths greater than 18" 5" maximum width

Cellular Shade Collection GENERAL INFORMATION

Cellular Shade MEASURING INSTRUCTIONS

Comfortex accepts measurements down to $\frac{1}{16}$ " increments.

Inside Mount

Use a steel tape to measure the opening at three different places, and use the narrowest dimension when ordering. Be exact! The factory will make the shade $\frac{3}{16}$ " narrower so it will not rub against the window casing. Measure the height of the window from the top (soffit) down to the sill.

Outside or Ceiling Mount

Use a steel tape to measure the exact height and width of the area to be covered. It is recommended that the shades overlap the window by at least $1\frac{1}{2}$ " on each side. When installation has no sill, allow the shade to overlap the bottom of the window casing by at least $1\frac{1}{2}$ ". Shade fabric will measure width indicated on the order form.

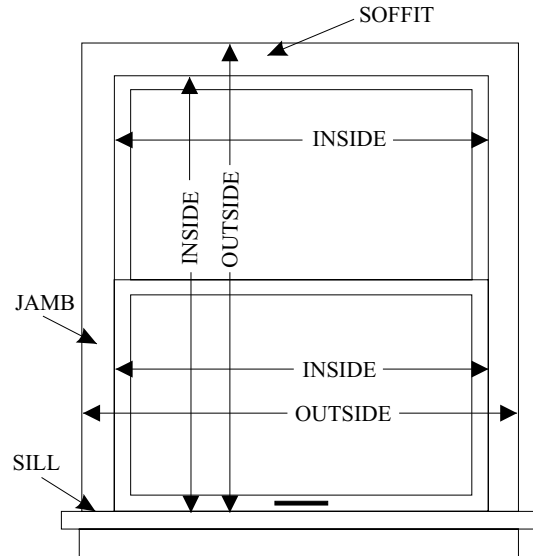

Measuring for Specialty Shapes

Templates are required with some specialty shade orders. Consult the individual product sections of this guide for specifics regarding accurate measurements and mounting information.

Arches and Quarter Round Circles

- Measure the window height and width appropriately for an inside or outside mount.
- With perfect arches, the height will be one half the width. With perfect quarter rounds, height will equal width. If the arch or quarter round is perfect, **a template is not required.**
- Windows with imperfect arch measurements do not maintain the height/width relationship. Templates **are required** for these windows.

Trapezoids

- Measure the window height and width appropriately for an inside or outside mount. For outside mounts, remember to add the desired amount of overlap.
- Measure all four sides for accurate fabrication. Provide all measurements. **Templates are not required.**
- The slope angle must be measured with a protractor. Slope is the angle between slope and a horizontal line. The maximum slope is 30 degrees.

Octagons

- Measure the window height and width appropriately for an inside or outside mount. Be sure to measure the width at the shade's widest point.
- Provide the width, length and the length of one side when ordering.

Cellular Shade Collection

GENERAL INFORMATION

Making the Perfect Template

Tape brown craft paper over the window opening. Be sure to allow plenty of overlap and check to see that the paper is smooth and pulled taut. Do not use newspaper as the ink can rub off on fabric. Do not use paper that has been folded. Notice the outline of the framework superimposed on the template as the light filters through the window. You may create the template in one of two ways:

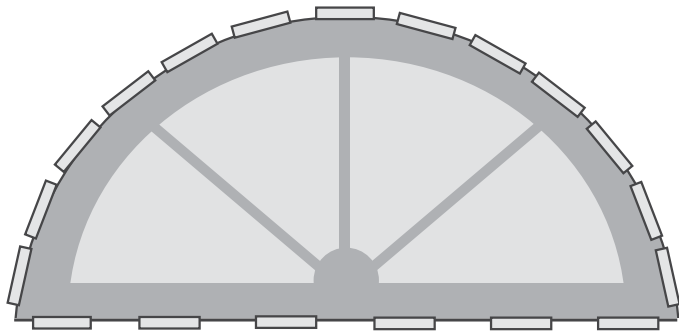

Trace the outline of the window with a pencil and continue along the side of the window frame. Once the window is completely traced, remove the craft paper from the window. Cut out the traced shape with a pair of scissors.

You may choose to skip tracing the window outline with a pencil and cut out the shape immediately with a razor knife.

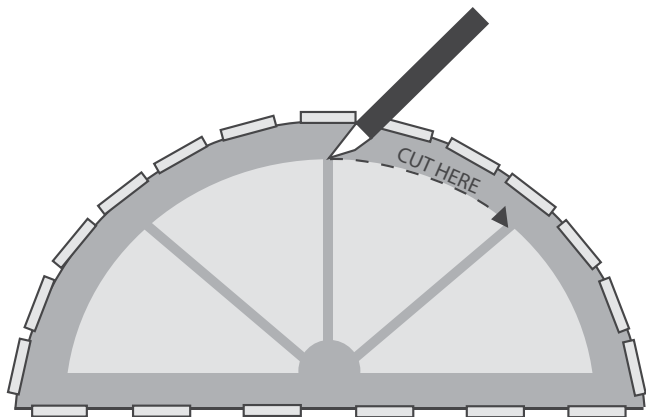

Once your template is cut, double check its width and height with your initial measurements. Test the template by placing it in the window. Check for light gaps, uneven cutting of curves etc. Trim or remake if necessary.

With arch top shades, fold the template in half. Check the outline of the curve for smoothness, light gaps and curve continuity. Place the template in the window and check it for light gaps or uneven cutting of curve. Trim or remake it if necessary.

On the front of the template, mark the shade measurements along with your company name, account number, sidemark, shade style and color. Be sure to indicate inside or outside mount, the room side and which ends of the template are top and bottom. Do not take any deductions on inside mount shades. The factory will make all necessary allowances for inside mounts.

Remember: The quality of the finished shades depends heavily on the quality of the template supplied. Do not hesitate to remake a template if you feel uncomfortable of the quality of your first attempt.

Template Kits: Comfortex offers template kits which includes brown craft paper, razor knife, instructions and order form. Please contact Customer Service or visit www.comfortex.com to order. Stock number: 751000

Cut-Outs

Cut-outs are available with all cellular fabrics.

Cut-outs are \$69.00 per side and are subject to approval by the Comfortex Technical Service department.

There are no limits on cut out lengths.

There are limits on cut out widths.

Cellular shade widths 18" or less: maximum 3" width cut-out

Cellular shade widths greater than 18": maximum 5" width cut-out

Cellular Shade Collection GENERAL INFORMATION

⚠️ WARNING

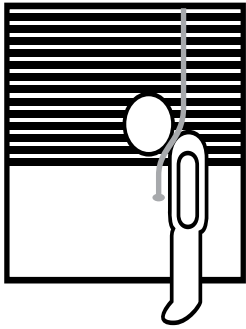

Window Blind Cord Can
STRANGLE Your Child.

To prevent strangulation, purchase
cordless products or products with
inaccessible cords.

⚠️ ADVERTENCIA

La cuerda ciega de la ventana
puede ESTRANGULAR su niño.

Para evitar el estrangulamiento,
compre alternativas inalámbricas o
productos con cables inaccesibles.

Child Safety

Comfortex has a long history of designing new child-safety products and is proud to provide a leadership role in cooperating with the Consumer Product Safety Commission (CPSC) for the development of policies and guidelines for the industry by serving on the WCMA Standards Development Committee.

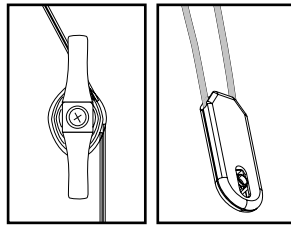

Cord Cleat

Cord
Tensioner

All Comfortex products have been fully tested and proven to comply with the current WCMA Standards for safety of corded window coverings.

Be aware that it is possible for children to become entangled in window covering cords. To reduce the risk of accidents, all cords must be kept out of the reach of children.

A cord cleat or cord tensioner is an effective way to implement this essential precaution. Please use them.

To mount the cord cleat at a safe height, take into account furniture or other objects upon which a child may climb. Then, after the use of the blind, simply wrap the excess cord around the cleat.

COMFORTEX CELLULAR SHADES

| | Page |
|---|--|
| Hardware Options | 1 |
| Size Standards | 4 |
| Hardware Option Availability | 12 |
| Hardware Upgrade Options. | 15 |
| PRICE GRIDS | |
| Standard Rectangular - Cord Lock Cordless Lift & Lock | Price Group 1-8. 18 |
| SlumberShade. | Price Group 9 25 |
| Ovation Cellular Slider. | Price Group 10-11. 26 |
| Starburst Arches | |
| Quarter Rounds. | Price Group 12-13. 28 |
| Sunset Movable Arches. | Price Group 14-15. 30 |
| Trapezoids and Octagons | Price Group 16-17. 32 |
| Soprano Skylights | Price Group 18-19. 34 |
| Balcony Skylight Shadings | Price Group 20-21. 35 |
| Mezz Motorized Skylights | Price Group 22-23. 37 |
| Non-Movable French Door Decor - Light Filtering. | Price Group 24 39 |
| Movable French Door Decor - Light Filtering. | Price Group 25 40 |
| Non-Movable French Door Decor - Room Darkening | Price Group 26 41 |
| Movable French Door Decor - Room Darkening | Price Group 27 42 |
| HARDWARE | |
| Standard Cord Lock. | 44 |
| Cord Loop | 46 |
| Cordless Ultra | 48 |
| Cordless Lift & Lock. | 50 |
| 12V Non-Rechargeable Simplicity Motorization | 52 |
| 7.4V Rechargeable Simplicity Motorization. | 54 |
| 7.4V Rechargeable Motorized Top Down-Bottom Up | 57 |
| 7.4V EZ Charge Extension Wand | 59 |
| 12V Simplicity Low Voltage Hardwiring System | 60 |
| Simplicity Smart Controller | 61 |
| 7.4V Rechargeable PowerTouch Motorization | 62 |
| Ovation Cellular Slider. | 64 |
| Insulating Slumbershades | 66 |
| Starburst Arches | 68 |
| Sunset Arches | 69 |
| Quarter Rounds. | 71 |
| Trapezoids and Octagons | 73 |
| Soprano Skylights and Greenhouse Shades | 75 |
| Balcony Shadings | 77 |

| | |
|--|-------------|
| COMFORTEX CELLULAR SHADES- CONTINUED | Page |
| 7.4V Mezzo Rechargeable Motorized Skylight | 79 |
| French Door Decor | 82 |
| Day-Night Shades | 84 |
| Custom Graphic Shades | 86 |
| GENERAL INFORMATION | |
| EZ Level | 91 |
| Cleaning and Care. | 92 |
| Measuring | 93 |
| Making A Template | 94 |
| Child Safety | 95 |



Midwest
Designer
Supply

1-888-523-2611

**Midwest Designer Supply, Inc.
N30W22377 Green Road Ste C
Waukesha, WI 53186
(262) 523-2600
Fax (262) 524-1007
www.midwestdesignersupply.com**

MDS - your one source for window fashions.